



Orhtopedic Instruments

SMS industries



Manufacturers, Stockiest & Supplier of Surgical Instruments

ORTHOPEDIC INSTRUMENTS CATALOGUE



- ★ Amputation, Elevators, Raspatories, Saws, Bone Livers, Bone Files & Curettes
- ★ Mallets, Tampers, Chisels, Gauges, Bone Holding Forceps, Bone Rongeurs, Bone Cutting Forceps, Meniscus Instruments
- ★ Wire Extension

Amputation and Resection Knives



www.smsindus.com

Double Cutting

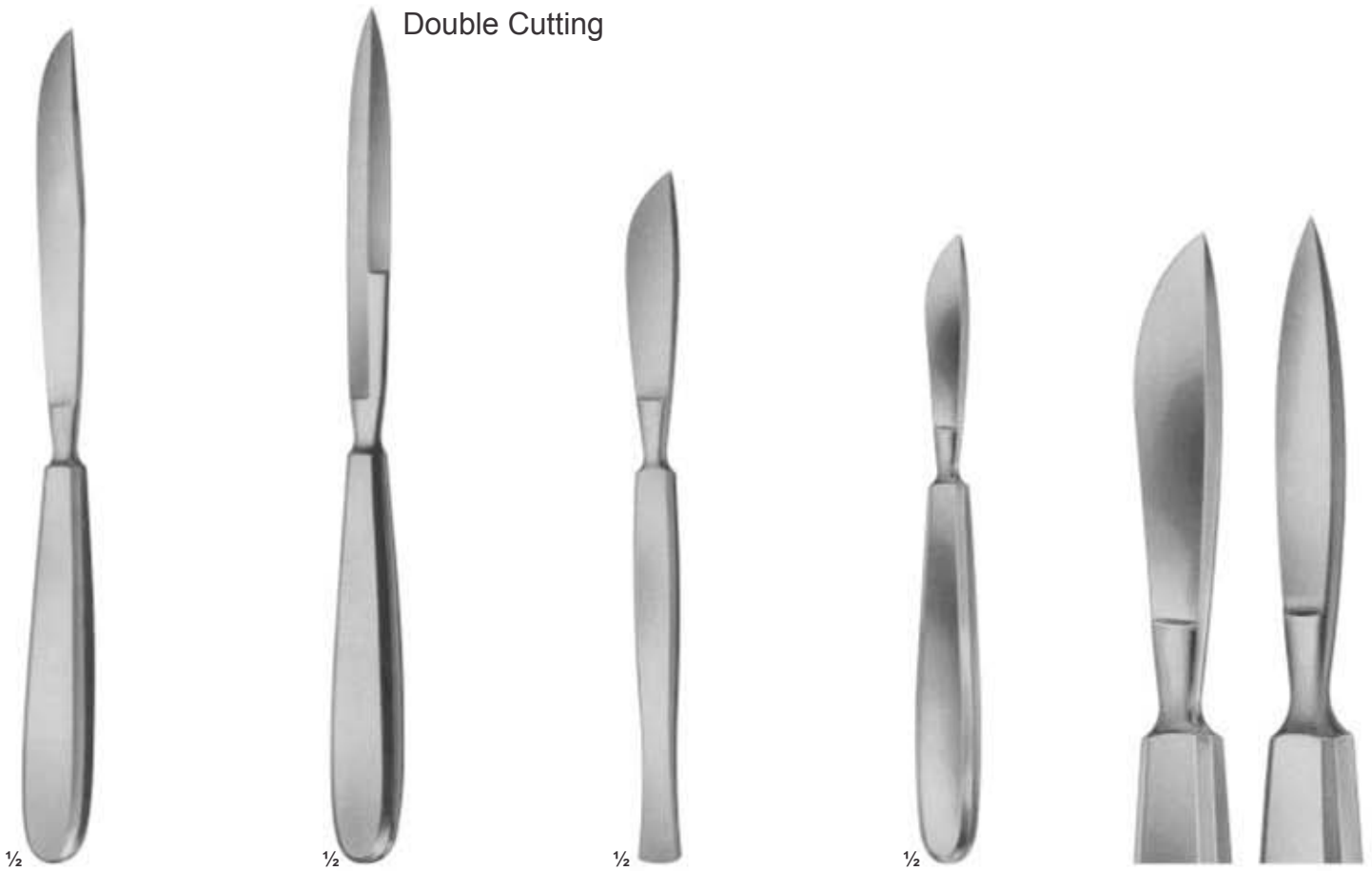

06-8001
Length of blade
Phalangeal knife
105 mm

06-8002
Length of blade
Interosseous knife
110 mm

06-8003
Length of blade
Periosteum knife
with raspator
65 mm

06-8004 - 06-8005
LANGENBECK
Length of blades
Resection knives
55 mm

06-8004 **06-8005**

Amputation Retractors

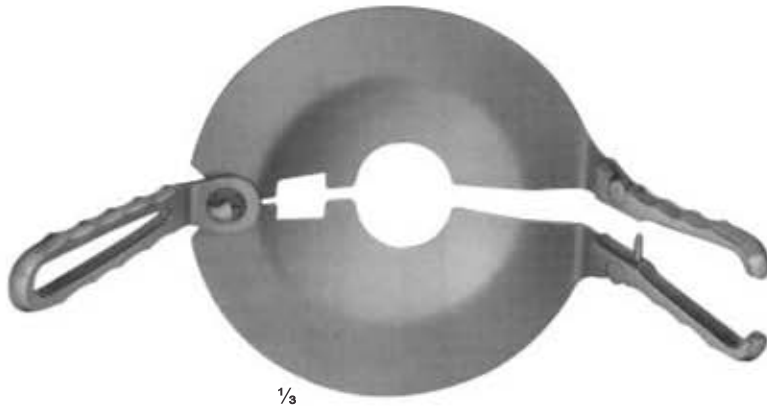

06-8006
PERCY
removeable handles



06-8007
PERCY
reversible handles

Amputation Saws



www.smsindus.com



1/3

06-8008
CHARRIERE
Length of blade
215 mm
complete with one saw
blade each(**06-8009** and **06-8010**)
350 mm

Spare saw blades, carbon steel
06-8009 12 mm
06-8010 20 mm



1/3

06-8011
RUST
Length of blade
235 mm
complete with one saw
blade each(**06-8013**, **06-8014**
and 2 saw blades **06-8015**)
390 mm
06-8012 Bow only

Spare saw blades, carbon steel
06-8013 6 mm
06-8014 8 mm
06-8015 12 mm
06-8016 20 mm

Amputation Saws



www.smsindus.com

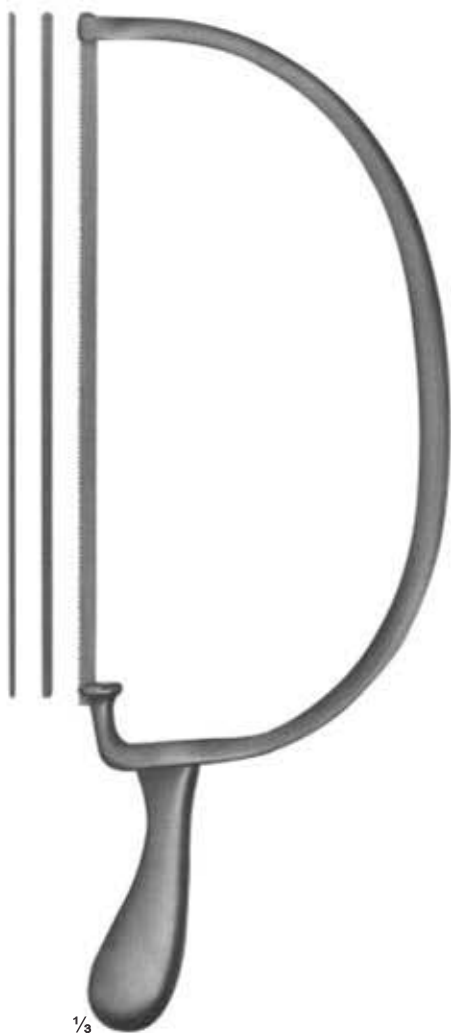

1/3

06-8017
BIER
Length of blade
270 mm
complete with one saw
blade each (**06-8018**, **06-8019** and **06-8020**)
420 mm

Spare saw blades, carbon steel
06-8018 4 mm
06-8019 6 mm
06-8020 8 mm



1/3

06-8021
CHARRIERE
Length of blade
180 mm
Spare saw blade,
carbon steel (**06-8022**)
270 mm

06-8023
CHARRIERE
Length of blade
240 mm
Spare saw blade,
carbon steel (**06-8024**)
340 mm



1/3

06-8025
SATTERLEE
Length of blade
200 mm
Spare saw blade,
carbon steel (**06-8026**)
200 mm



1/3

06-8027
LANGENBECK
Length of blade
115 mm
Metacarpal saw
235 mm

Wire Saws And Conductor



www.smsindus.com



06-8028 - 06-8031
OLIVECRONA
06-8028 300 mm
06-8029 400 mm
06-8030 500 mm
06-8031 700 mm



06-8032 - 06-8035
GIGLI
06-8032 300 mm
06-8033 400 mm
06-8034 500 mm
fine, 6 wires twisted
06-8035 500mm
coarse, 4 wires twisted



06-8036
GIGLI
Handle



06-8037
LEBSCHE
Conductor for
wire saws, malleable
250 mm

Elevators and Bone Levers

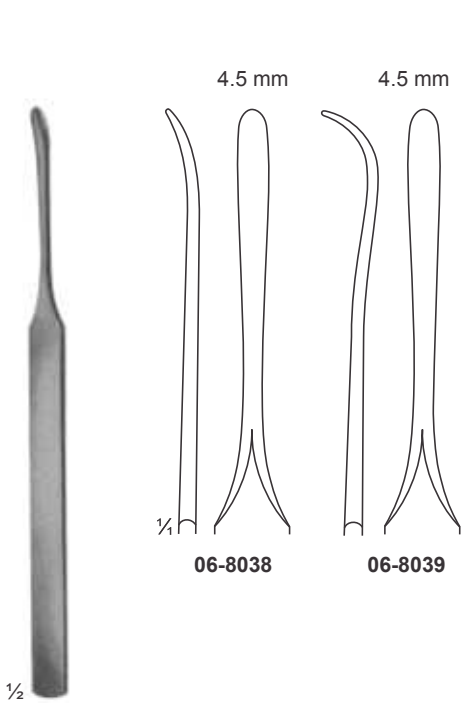

06-8038 - 06-8039
KOENIG
155 mm

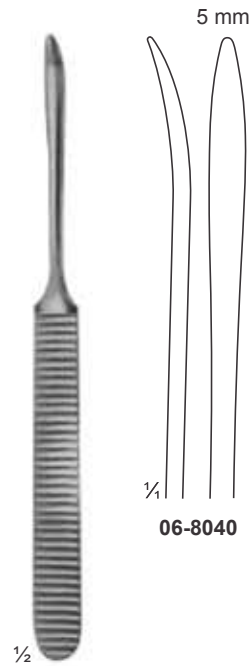

06-8040
WILLIGER
165 mm

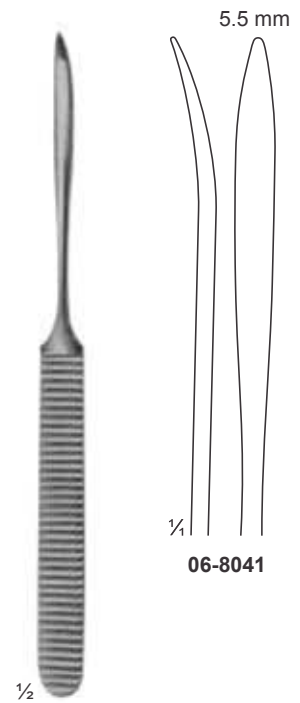

06-8041
WILLIGER
170 mm

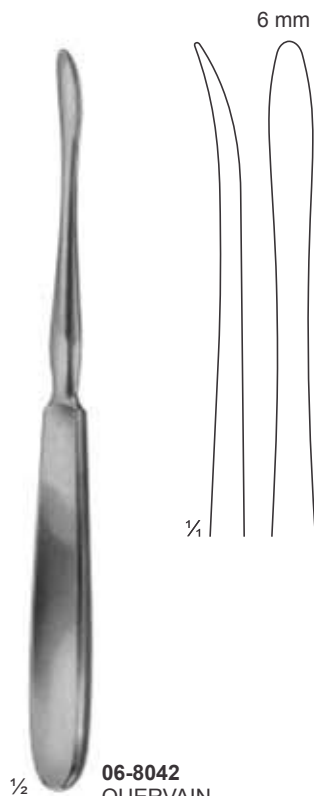

06-8042
QUERVAIN
195 mm

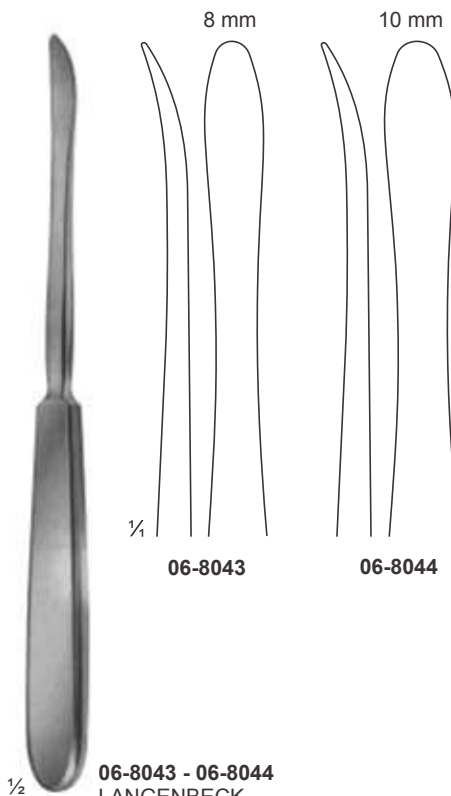

06-8043 - 06-8044
LANGENBECK
195 mm

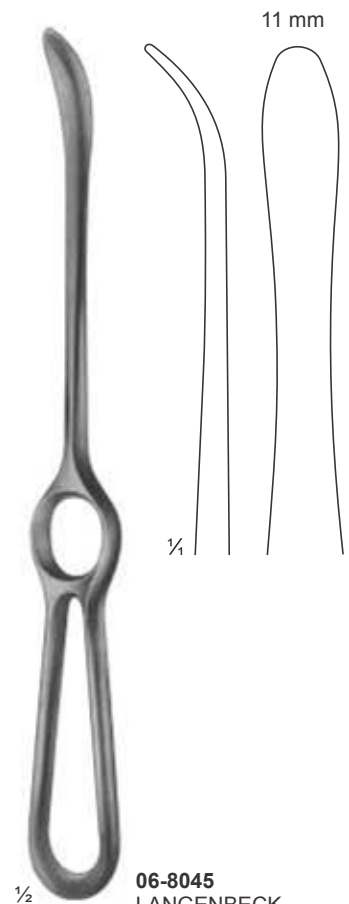

06-8045
LANGENBECK
230mm

Bone Levers

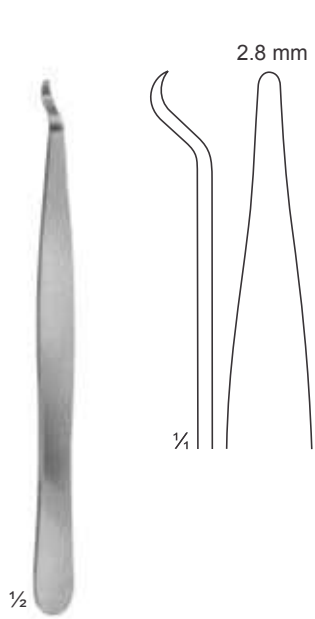

06-8046
140mm

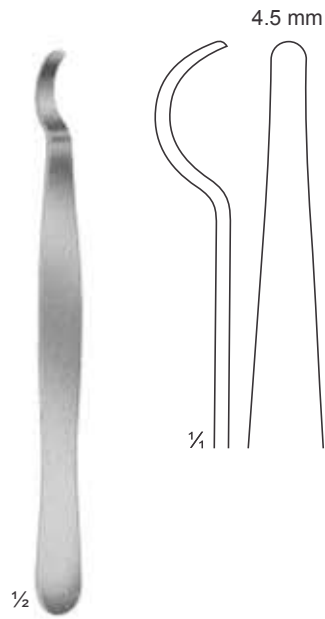

06-8047
150mm

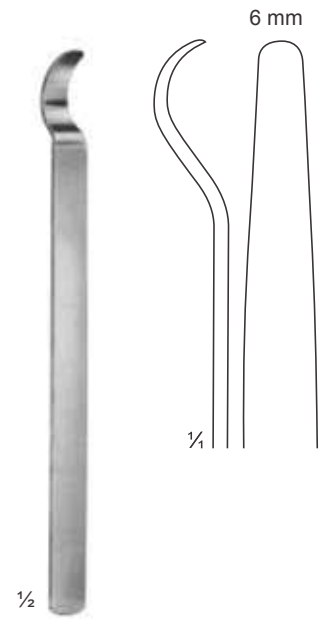

06-8048
150mm

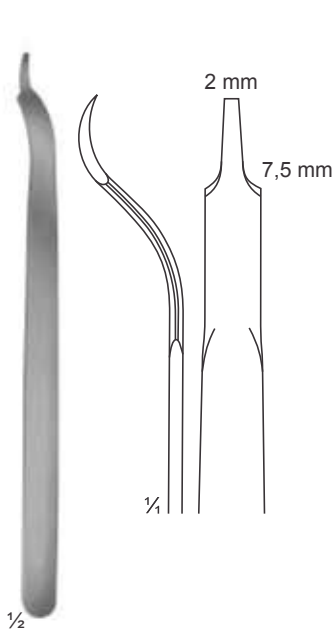

06-8049
BUCK-GRAMCKO
150mm

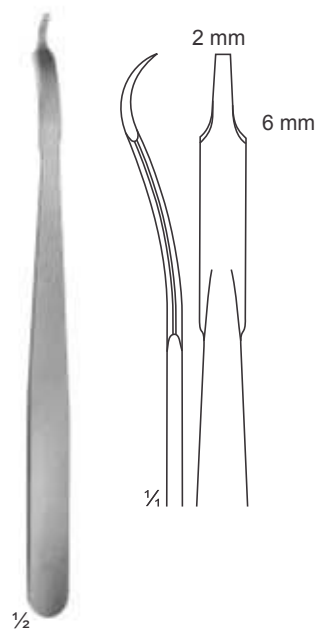

06-8050
160mm

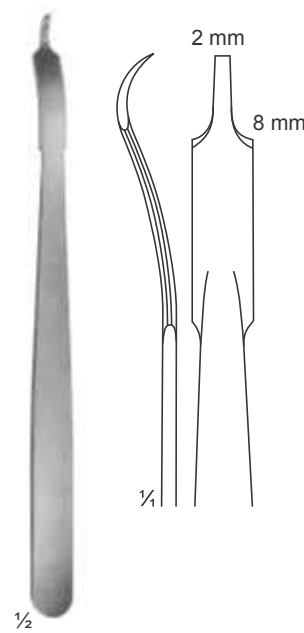

06-8051
160mm

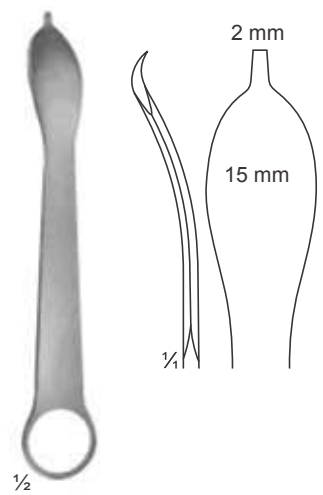

06-8052
125mm

Bone Levers



06-8053
LANE TRETHOWAN
215mm

06-8054
LANE
255mm

06-8055
LANGE-HOHMANN
250mm

06-8056 - 06-8057
LANGE-HOHMANN
modif
06-8056 265mm
06-8057 280mm

Bone Levers



06-8058
WAGNER
220 mm

06-8059
220 mm

06-8060
240 mm

06-8061
240 mm

Bone Levers

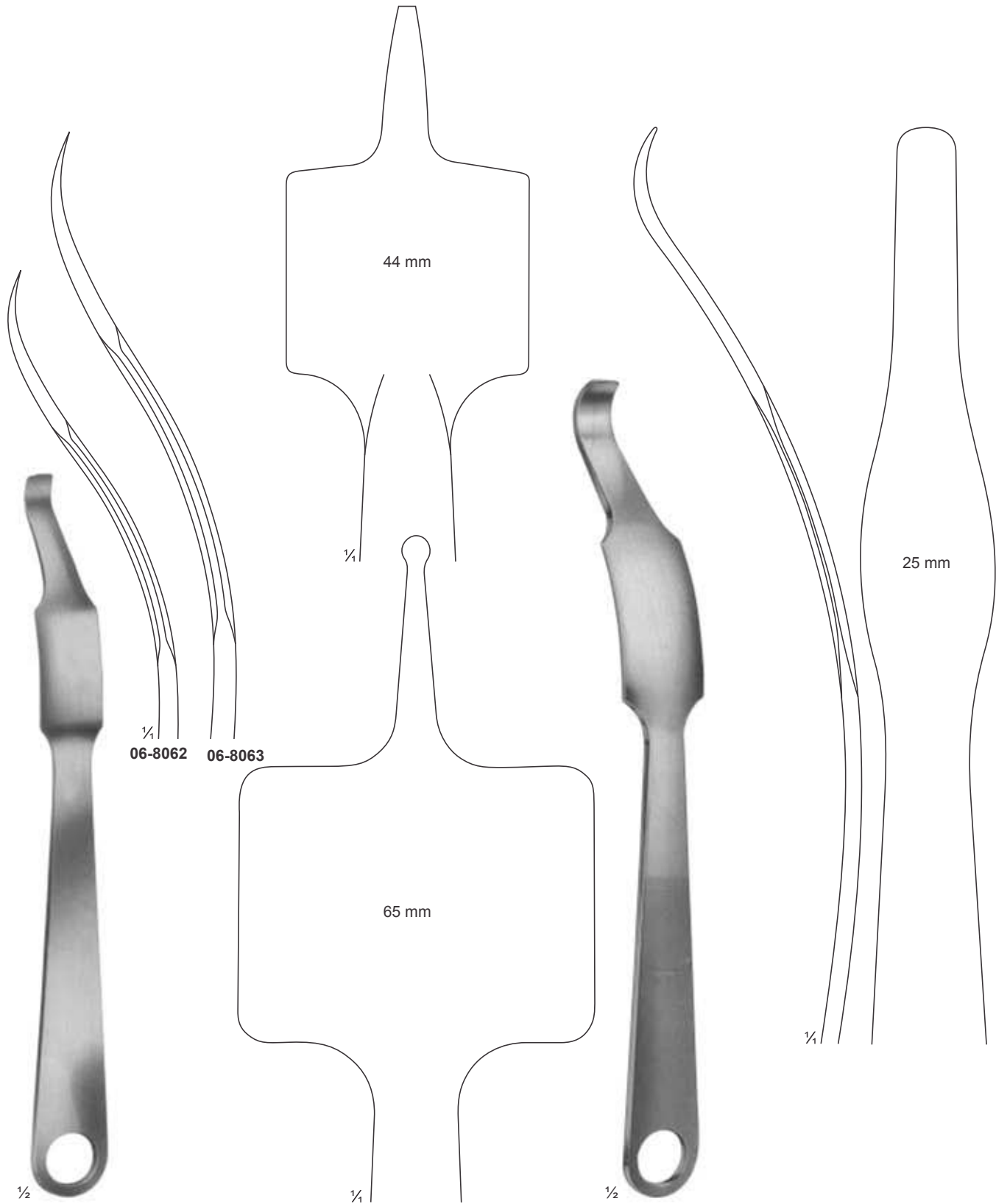

06-8062 - 06-8063
VERBRUGGE-MULLER
06-8062 240 mm
06-8063 255 mm

06-8064
 260 mm

Bone Levers

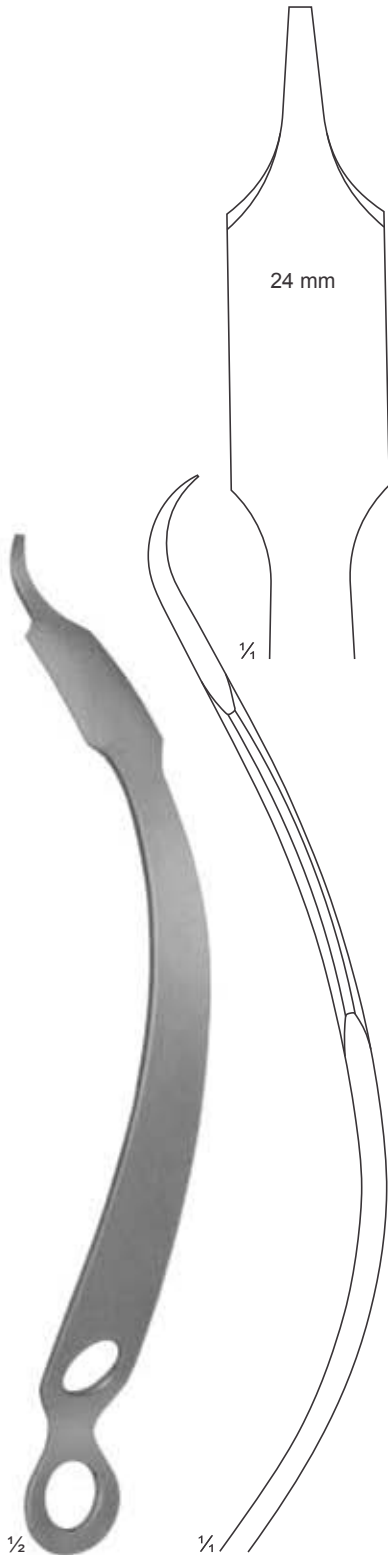

06-8065
HOHMANN-ALDINGER
270 mm



06-8066
SCHUMACHER mod. WAGNER
345 mm

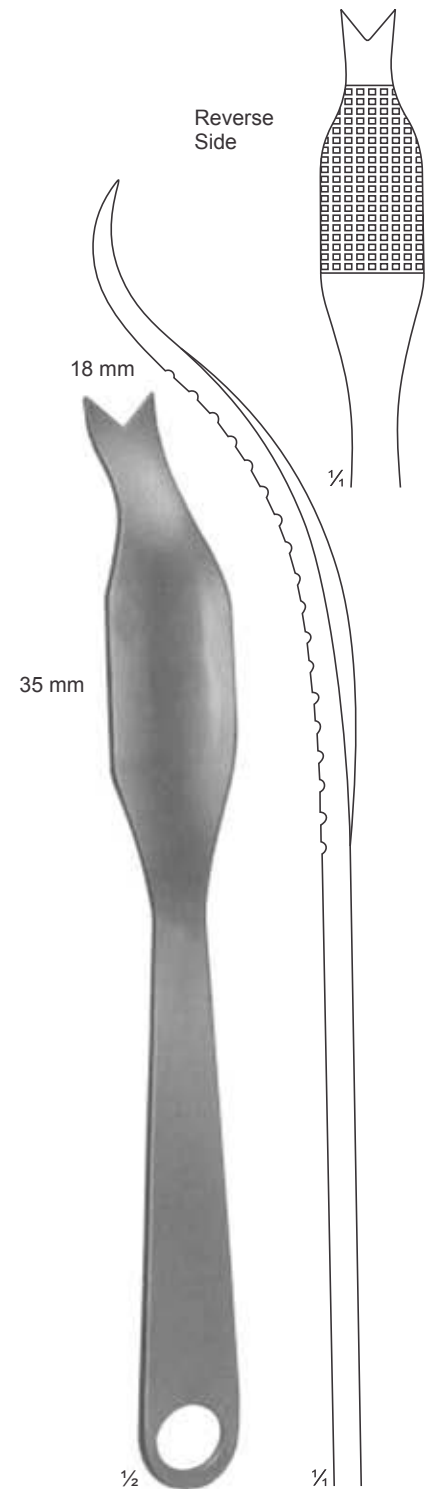

06-8067
SCHUMACHER
290 mm

Special Bone Levers

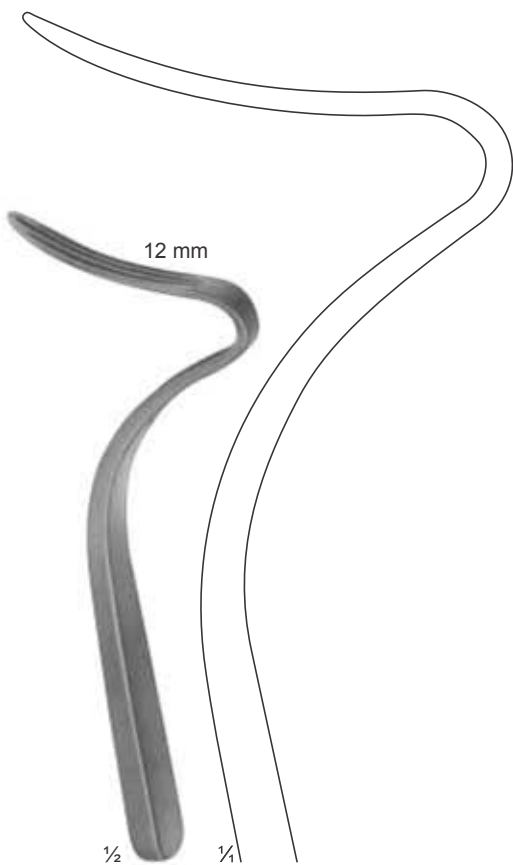

06-8068
TAGER
Bone lever for
angle joint operations
175 mm

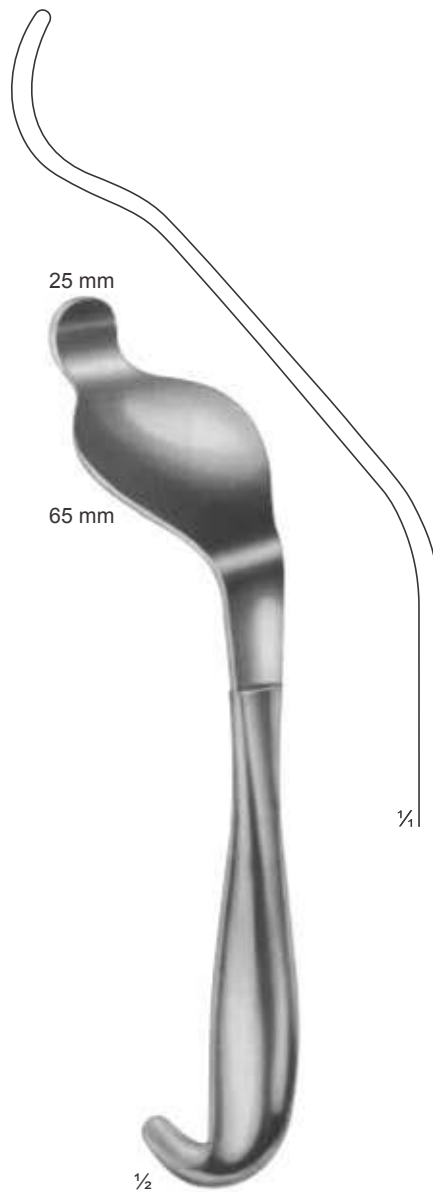

06-8069
BENNETT
235 mm

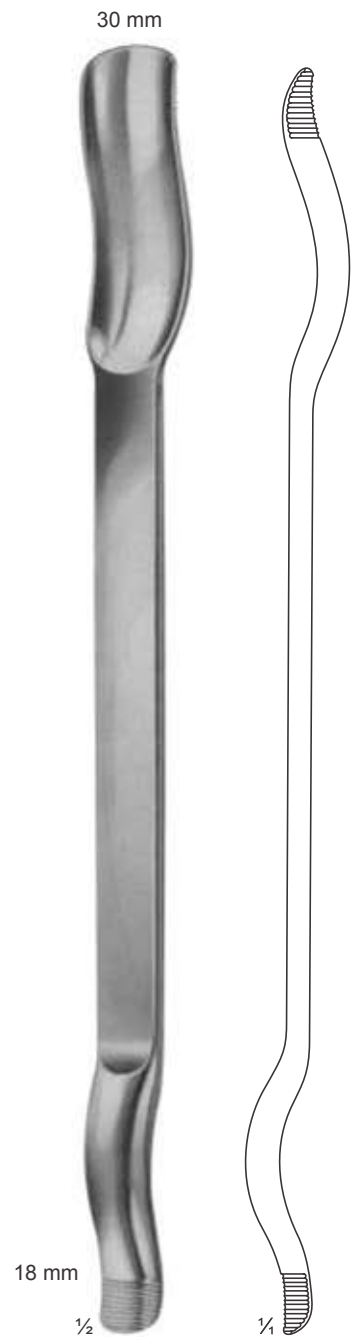

06-8070
MURPHY-LANE
Luxation lever
340 mm

Raspatories

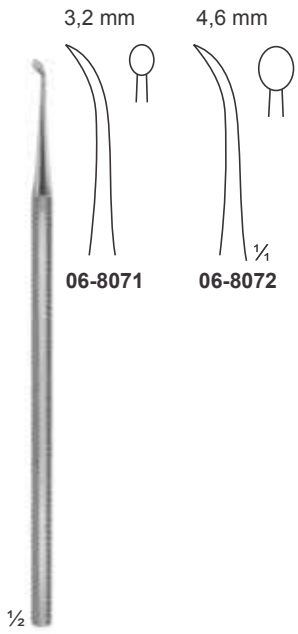

06-8071 - 06-8072
PARTSCH
150 mm

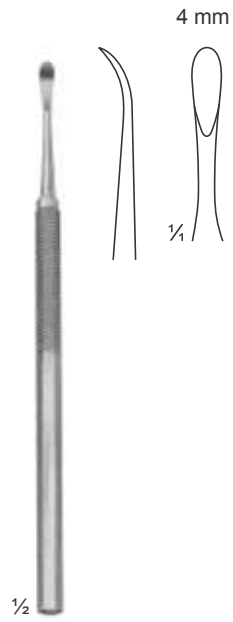

06-8073
PARTSCH mod. LANGE
145 mm

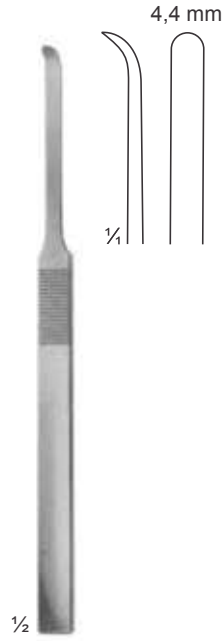

06-8074
MC KENTY
155 mm

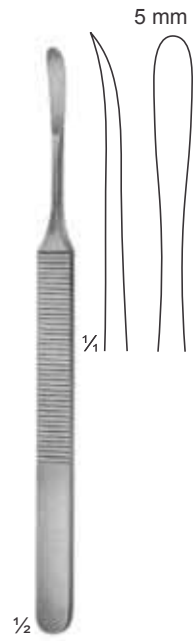

06-8075
KOENIG
155 mm

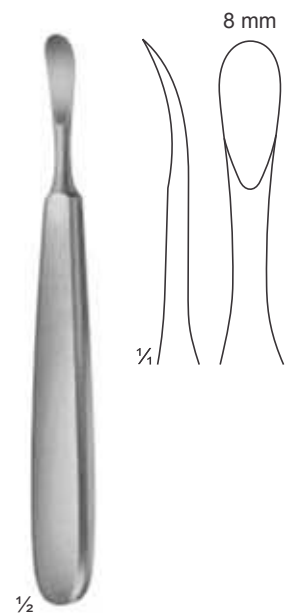

06-8076
TRELAT
150 mm

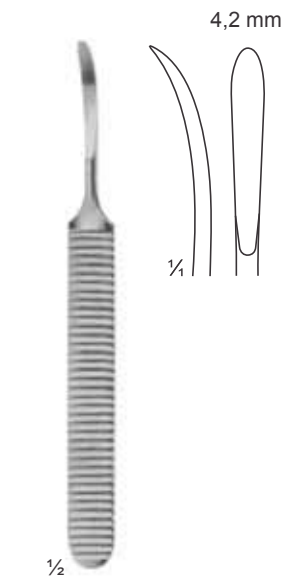

06-8077
WILLIGER
140 mm

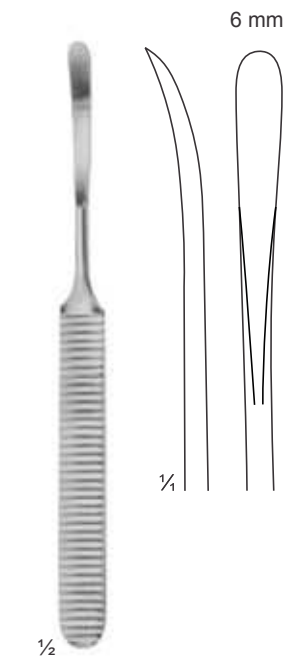

06-8078
WILLIGER
160 mm

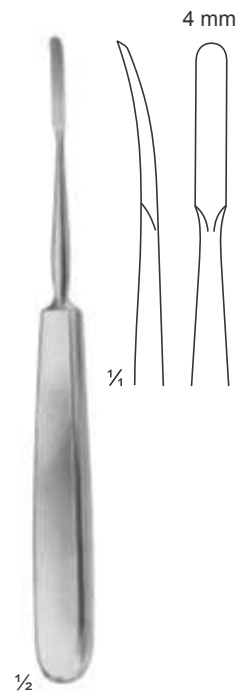

06-8079
JOSEPH
170 mm

Raspatories

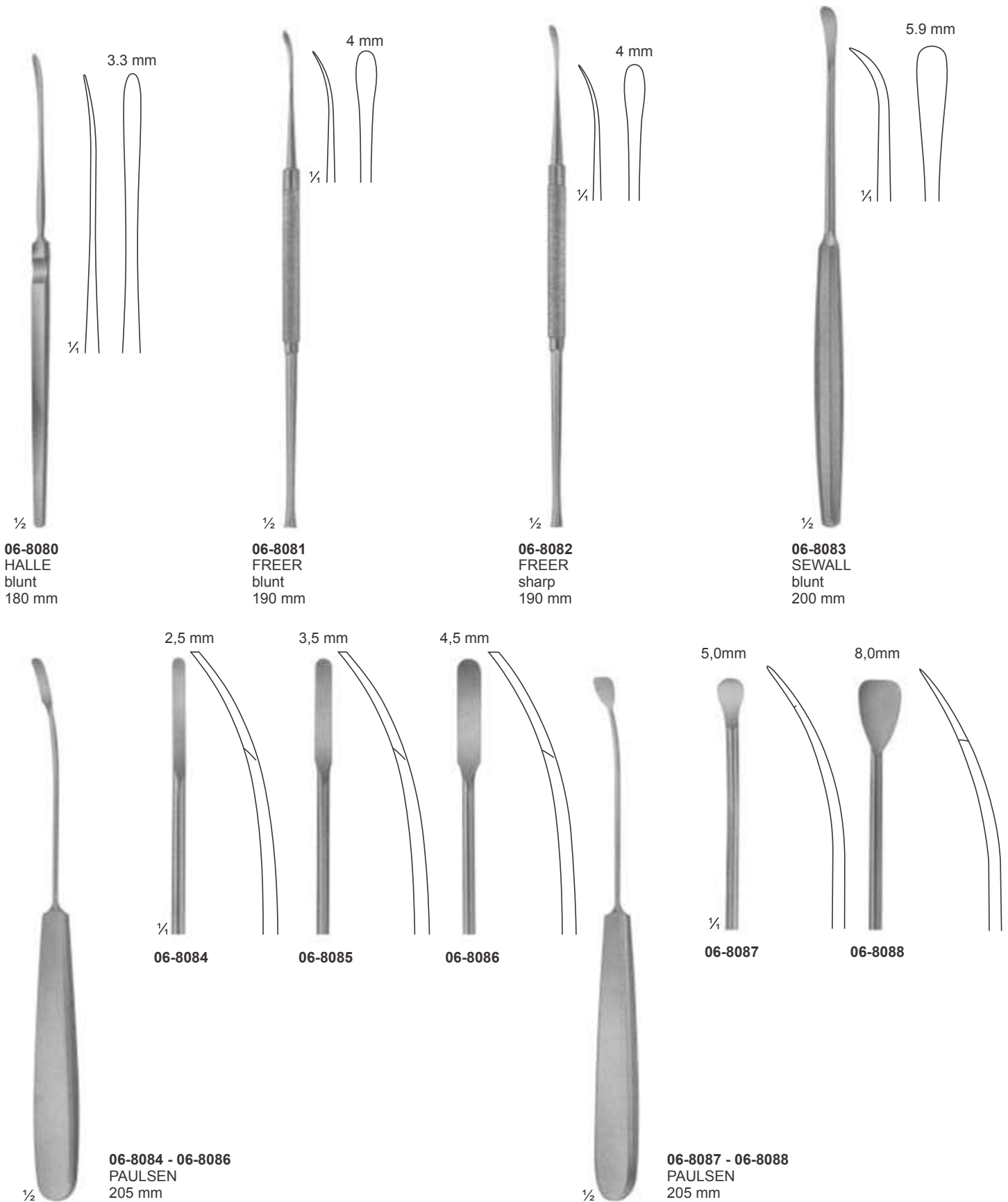

Raspatories

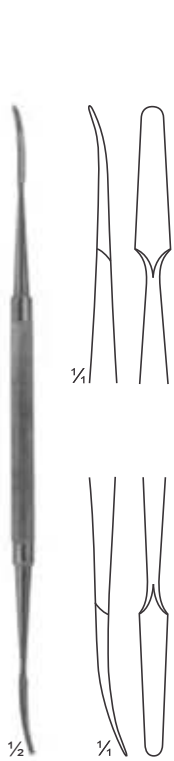

06-8089
KILLIAN
sharp/blunt
185 mm

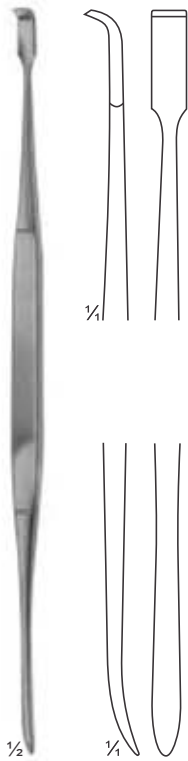

06-8090
HOWARTH
sharp/blunt
215 mm

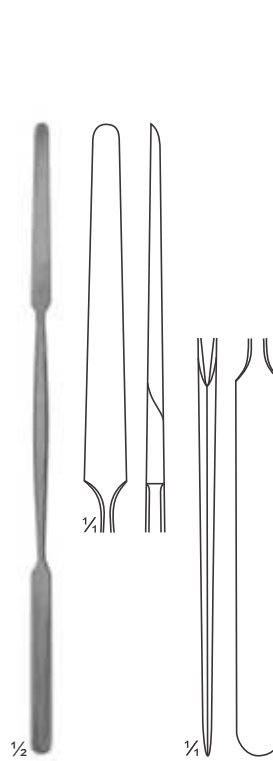

06-8091
KILLIAN
sharp/blunt
185 mm

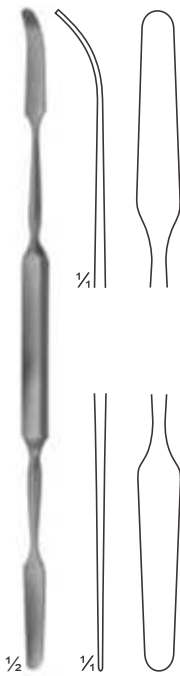

06-8092
MAC DONALD
blunt/blunt
185 mm

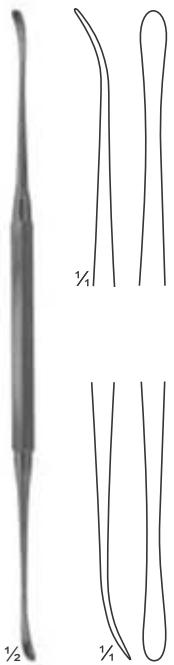

06-8093
FREER
sharp/blunt
185 mm

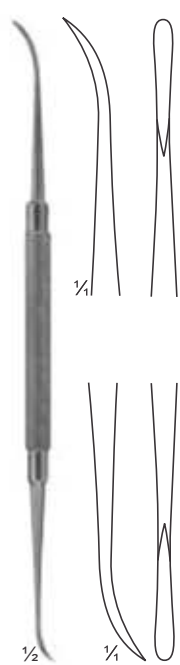

06-8094
FREER-YASARGIL
sharp/sharp
185 mm

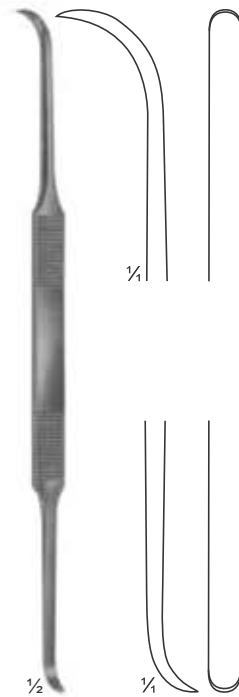

06-8095
COTTLE
sharp/sharp
200 mm

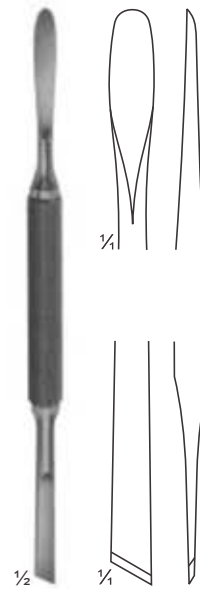

06-8096
MEAD
sharp/sharp
165 mm

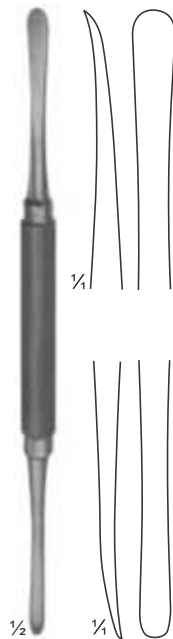

06-8097
MOLT
sharp/sharp
180 mm

Raspatories

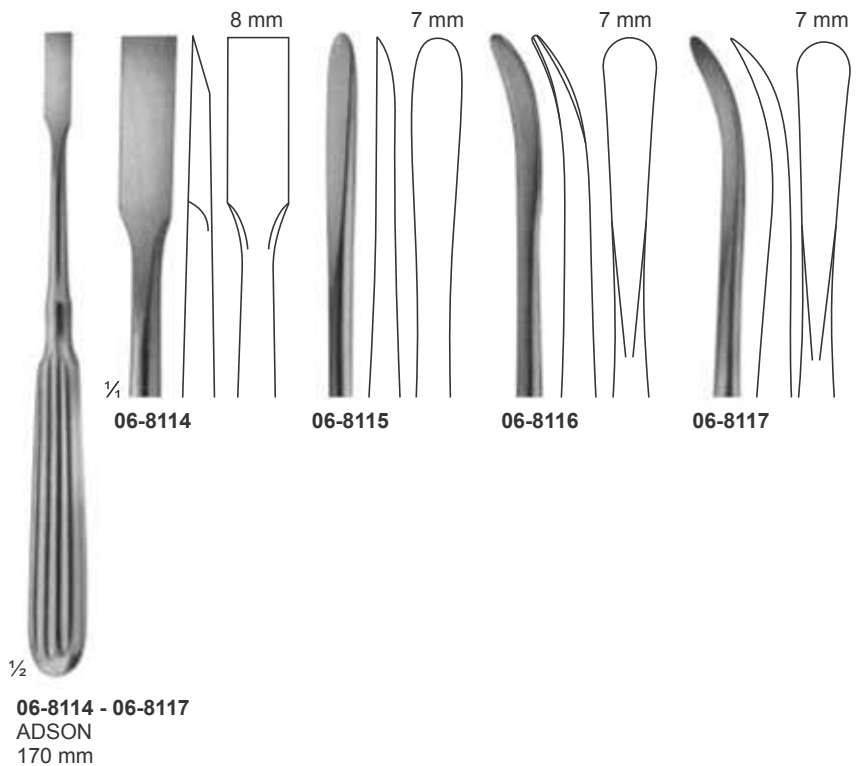
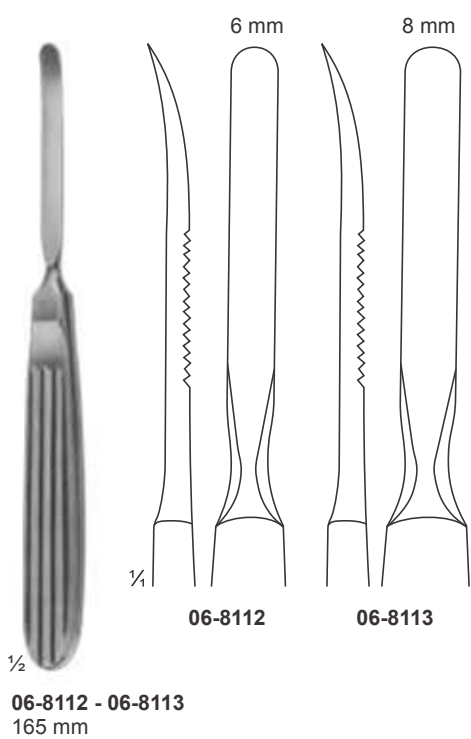
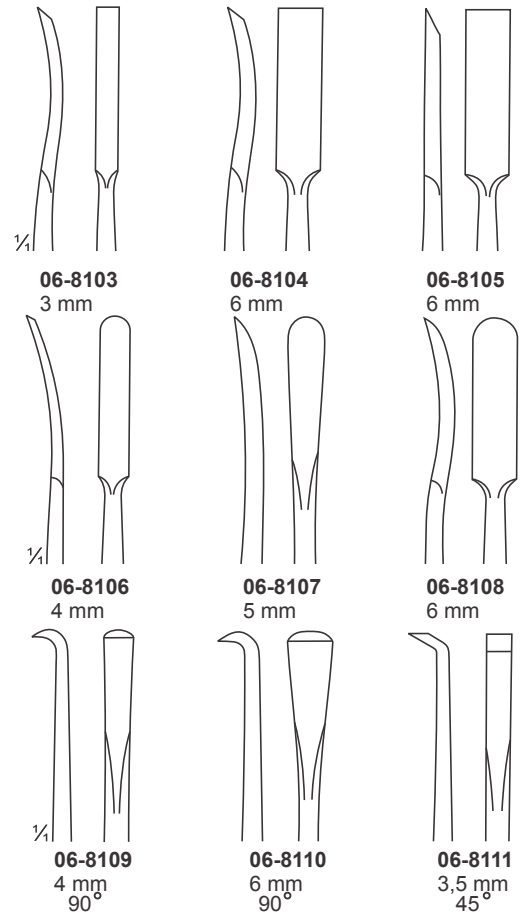
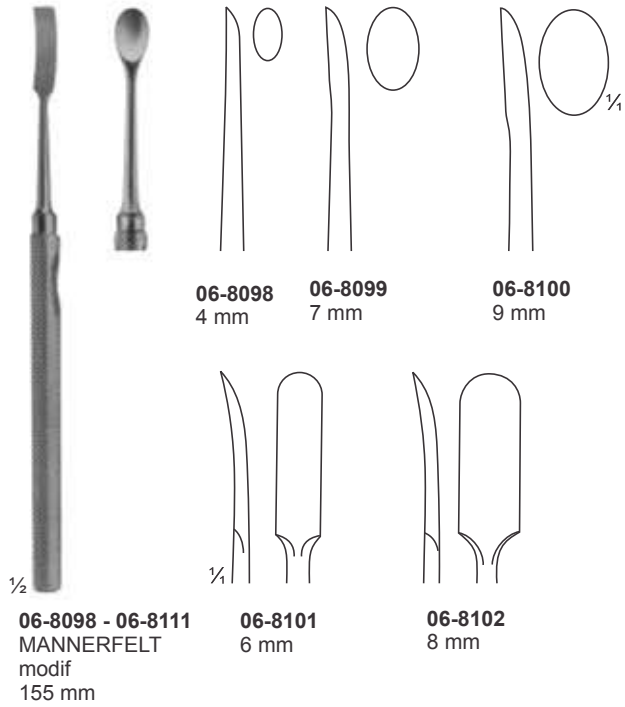

Raspatories

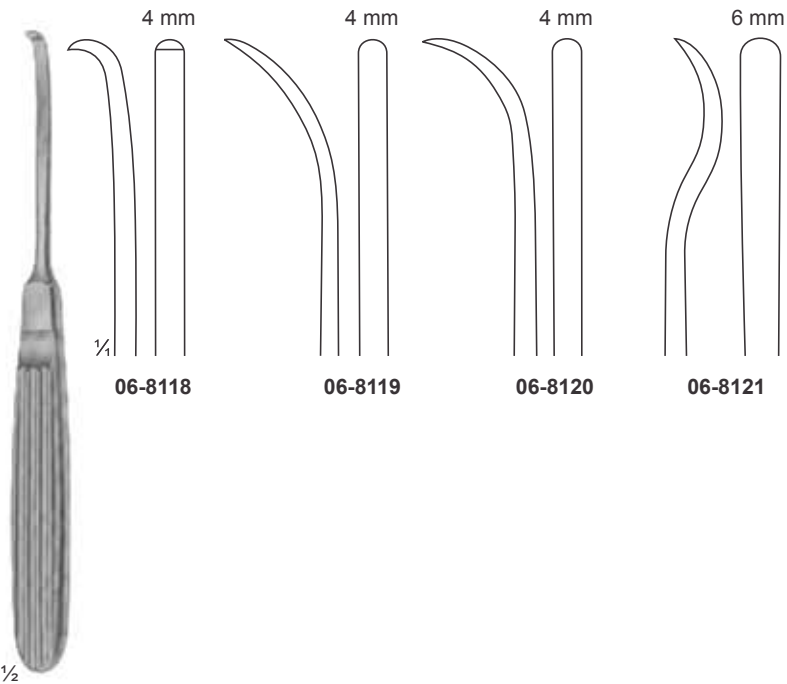

06-8118 - 06-8121
MUEHLING
170 mm

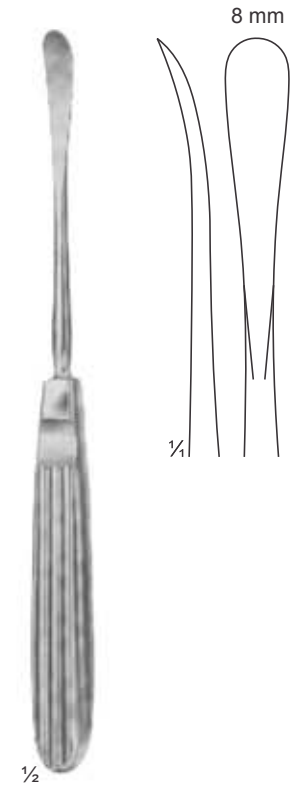

06-8122
COTTLE
195 mm

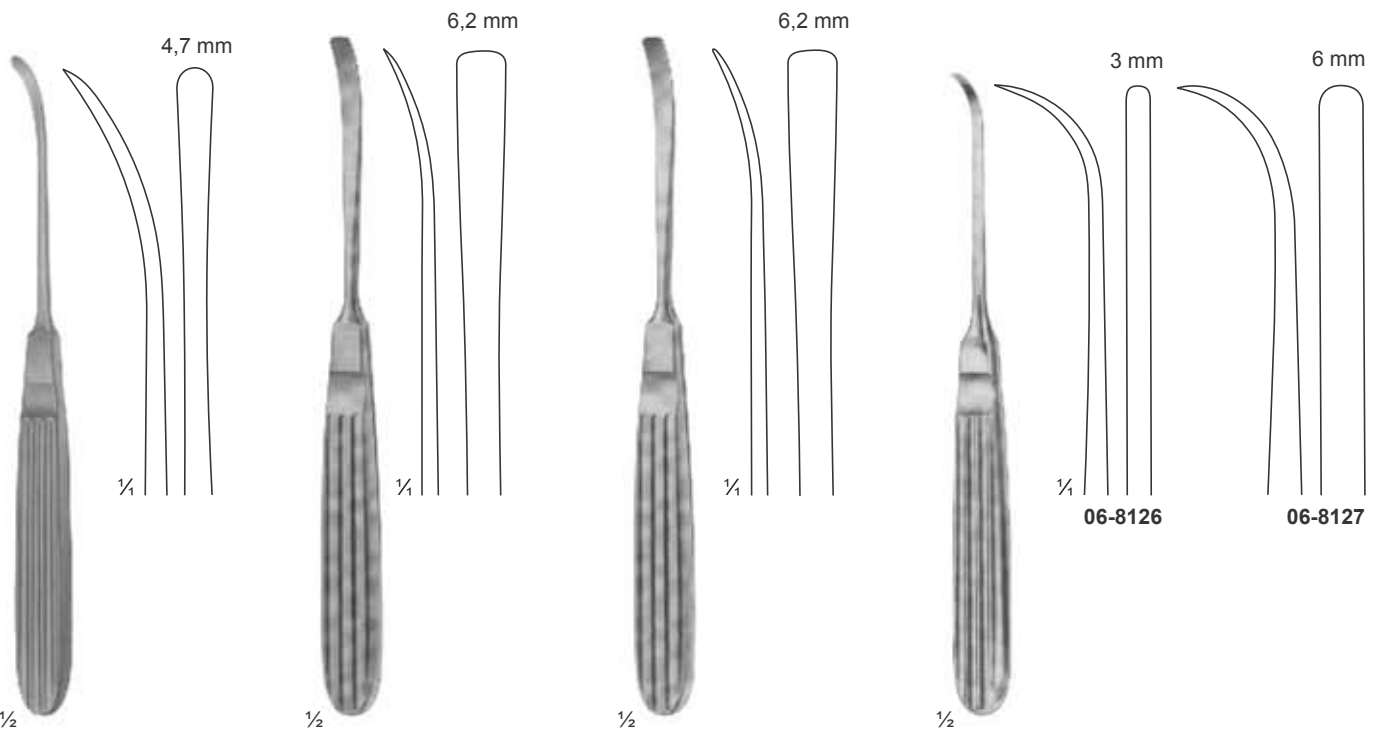

06-8123
LANDOLT
175 mm

06-8124
CASPAR
180 mm

06-8125
CASPAR
180 mm

06-8126 - 06-8127
170 mm

Raspatories

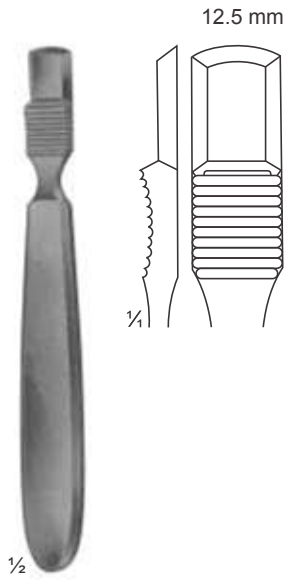

06-8128
FARABEUF
140 mm

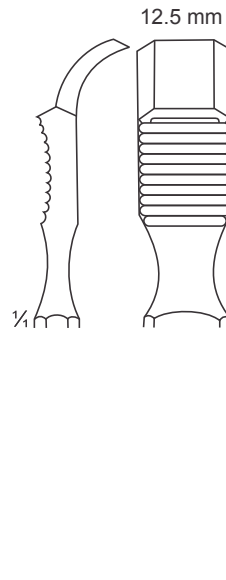

06-8129
FARABEUF
140 mm

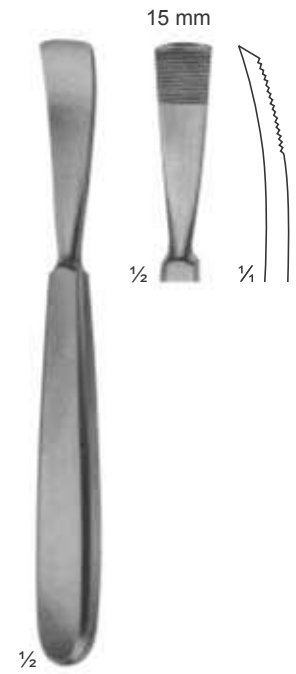

06-8130
JANSEN
165 mm

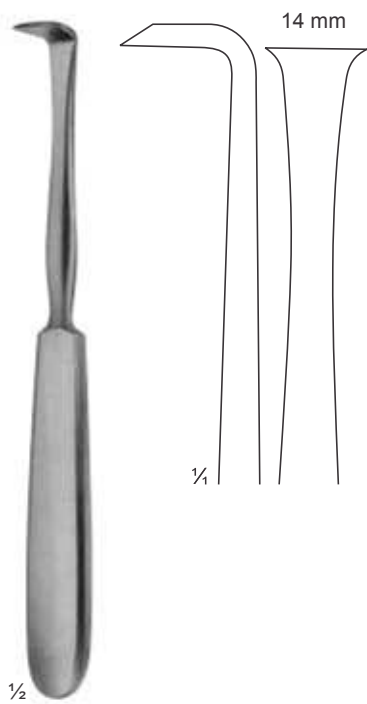

06-8131
LANGENBECK
180 mm



06-8132
SCHNEIDER
175 mm

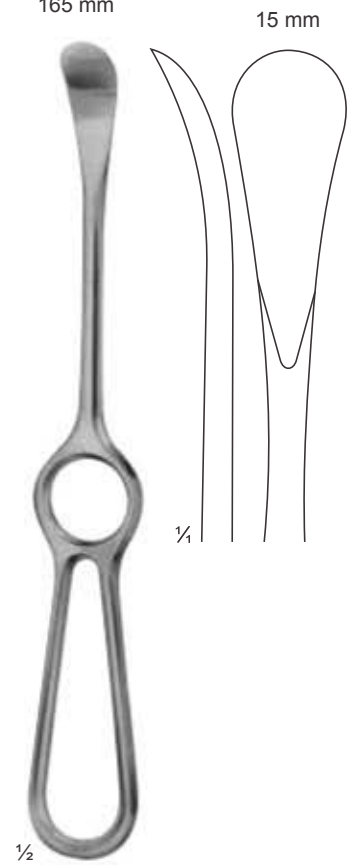

06-8133
SEDILLOT
215 mm

Raspatories

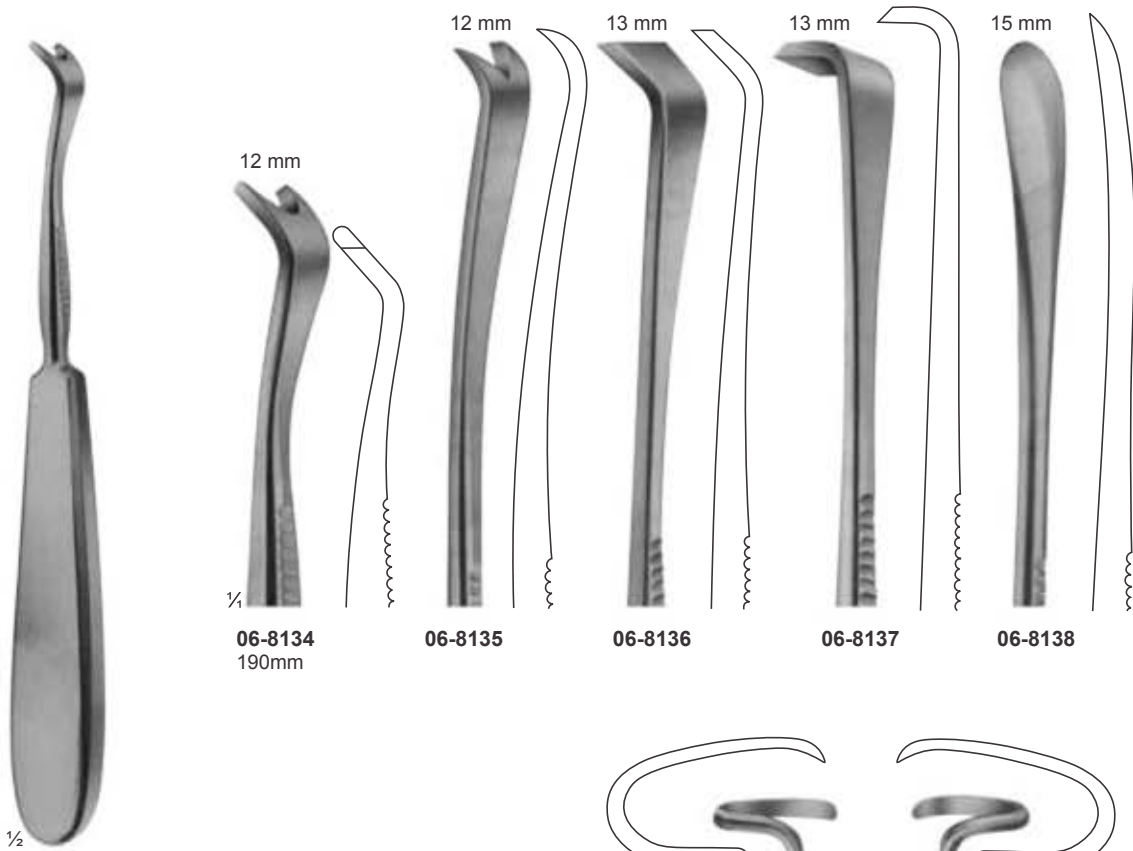

06-8134 - 06-8138
SEMB
230 mm

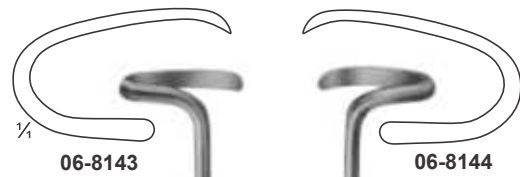

06-8143

06-8144

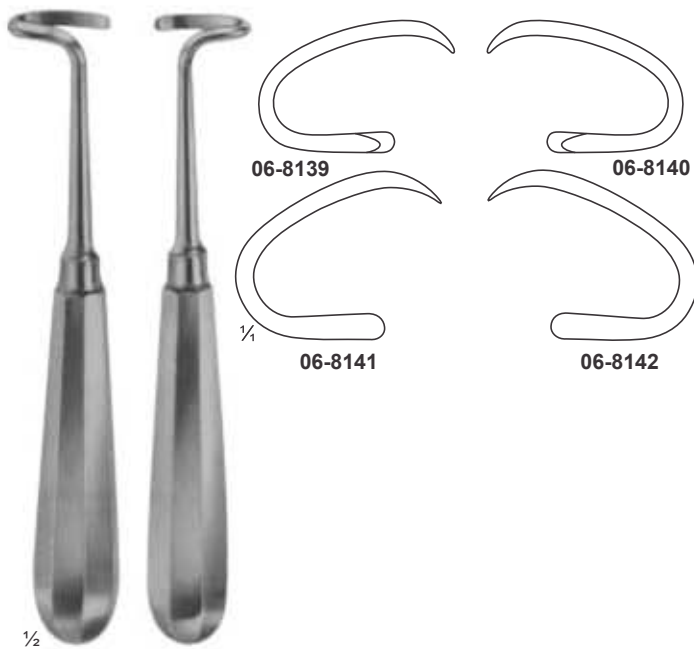

06-8139 - 06-8140
DOYEN for children
06-8141 - 06-8142
for adults 175 mm

06-8143 - 06-8144
DOYEN
240 mm

Raspatories with HARTPRESS-handle

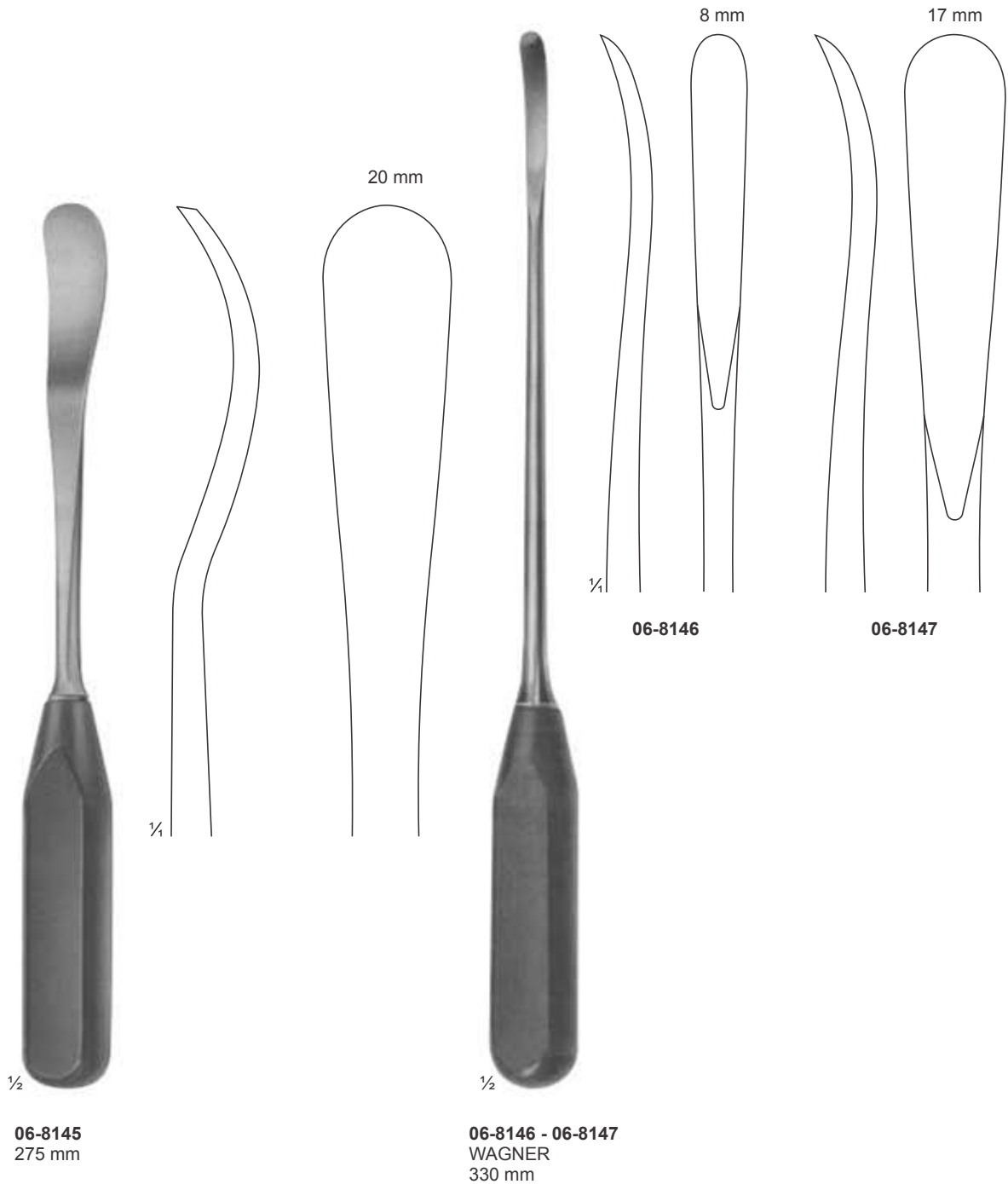

Bone File and Rasps

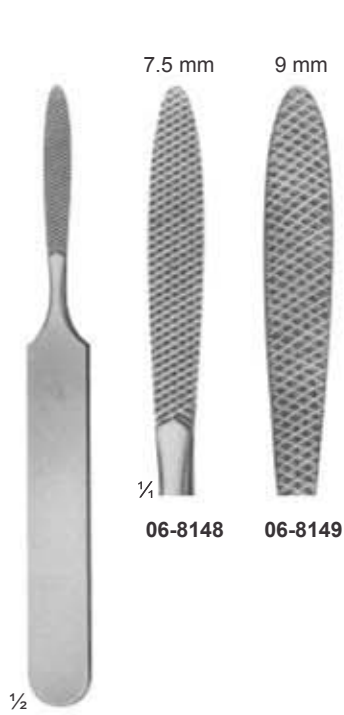

06-8148
JOSEPH
fine, chequered

06-8149
coarse, chequered
165 mm



06-8152
MALTZ
down stroke
180 mm



06-8153
AUFRICHT
up stroke
220 mm

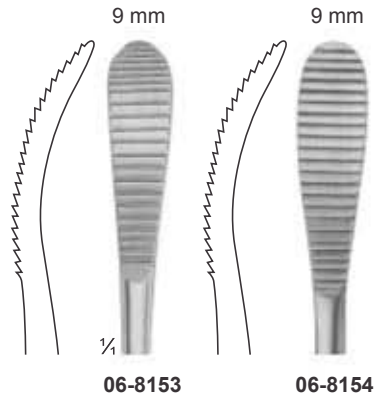

06-8153

06-8154

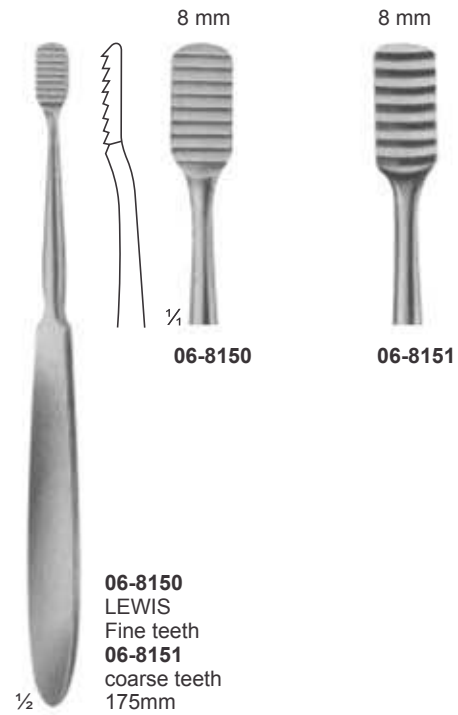

06-8150
LEWIS
Fine teeth
06-8151
coarse teeth
175mm



06-8155
GALLAHER
190 mm

Bone File and Rasps, Durogrip Rasps

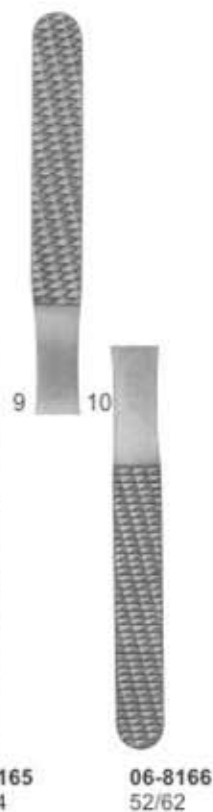
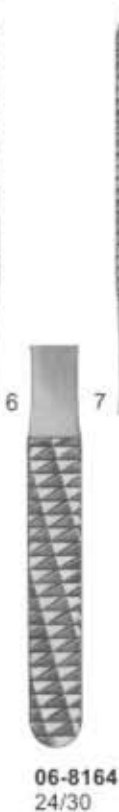
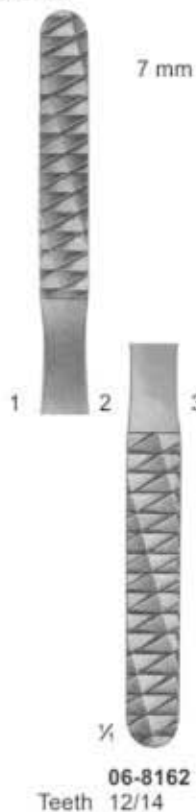
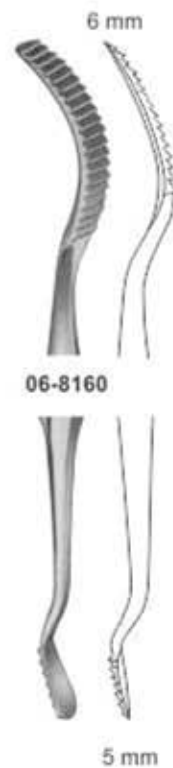
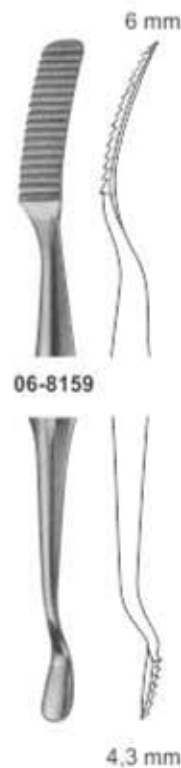
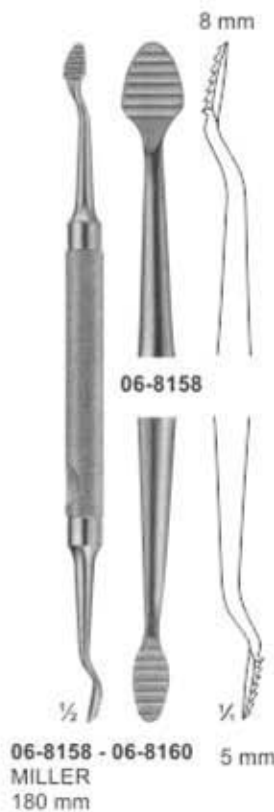

Bone File and Rasps

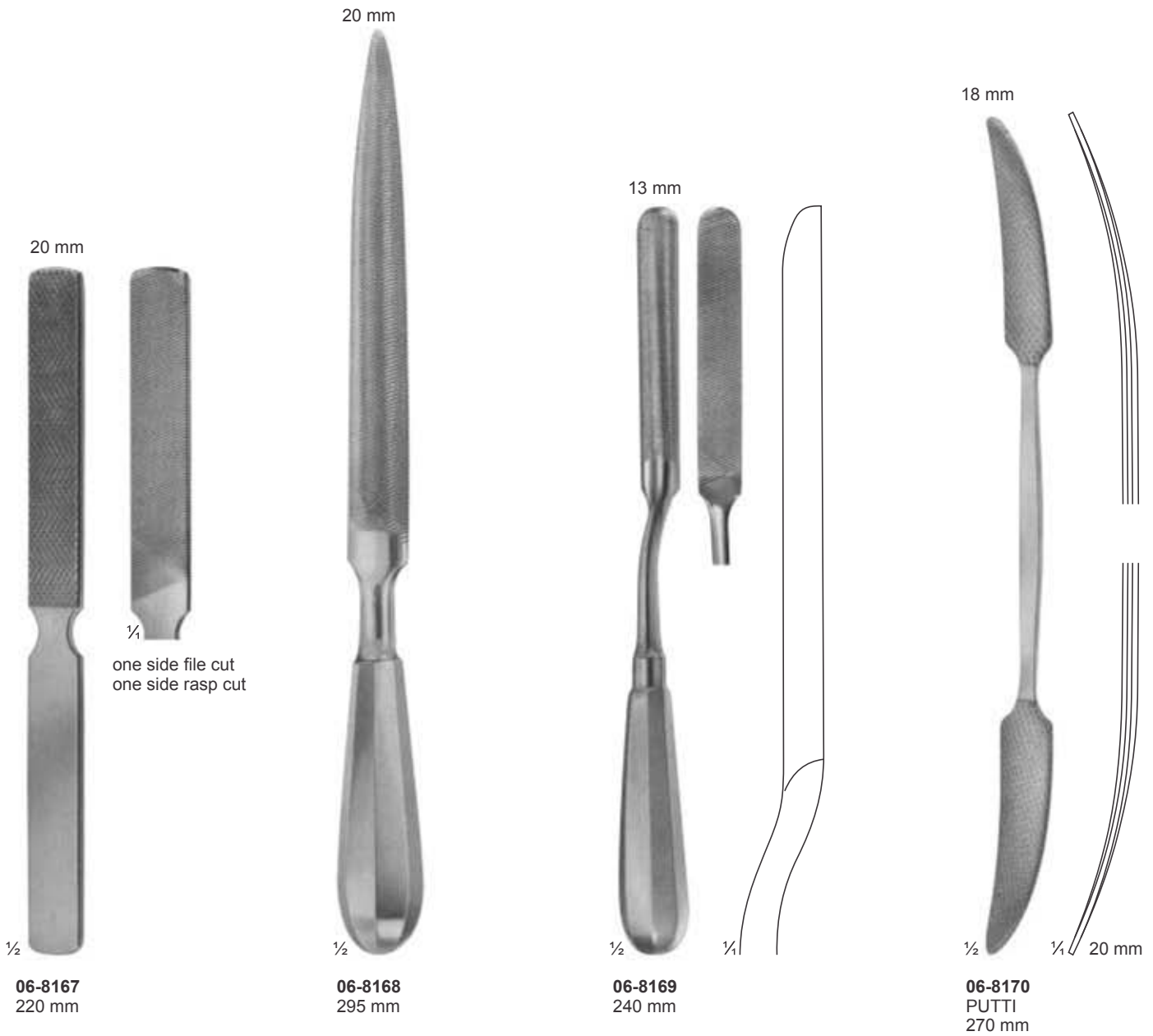

Bone Currettes



www.smsindus.com



06-8171
JACOBSON
140 mm

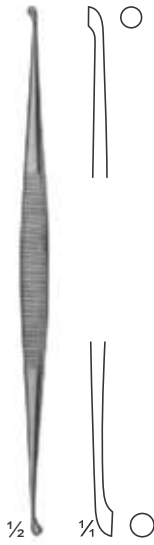

06-8172
MARTINI
140 mm

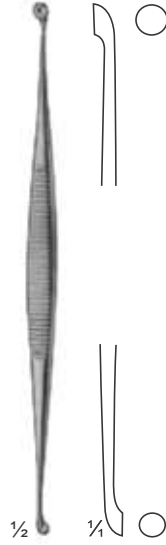

06-8173
MARTINI
140 mm



06-8174
WILLIGER
145 mm



06-8175
JANSEN
160 mm



06-8176
BARTH
180 mm

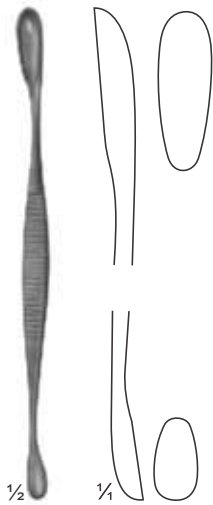

06-8177
VOLKMANN
130 mm

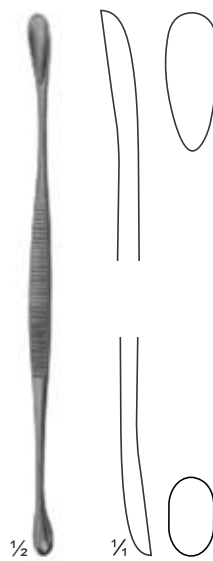

06-8178
VOLKMANN
145 mm

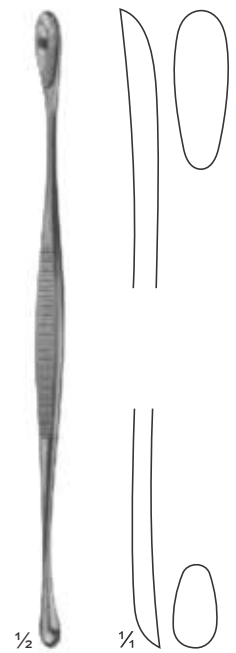

06-8179
VOLKMANN
170 mm

Bone Curettes



06-8180
JANSEN
160 mm



06-8181
HEMINGWAY
170 mm



06-8182
HEMINGWAY
175 mm



06-8183
LUCAS
180 mm



06-8184
LUCAS
185 mm

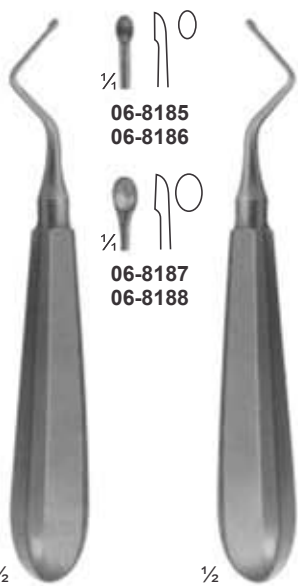

06-8185 - 06-8187
KERPEL
145 mm

06-8186 - 06-8188
KERPEL
145 mm

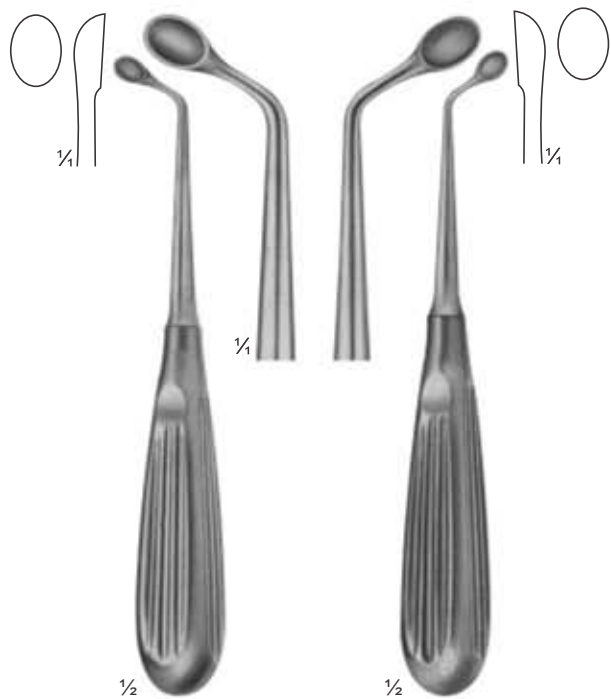

06-8189
UFFENORDE
170 mm

06-8190
UFFENORDE
170 mm

Bone Curettes



06-8191
3 mm
Fig: 000



06-8192
4 mm
00



06-8193
5 mm
0



06-8194
6 mm
Fig: 1



06-8195
8 mm
2



06-8196
10 mm
3



06-8197
12 mm
4

½

06-8191 - 06-8197
BRUNS
165 mm



06-8198
2,5 mm
Fig: 000



06-8199
3,4 mm
00



06-8200
4,2 mm
0



06-8201
5,2 mm
Fig: 1



06-8202
6,3 mm
2



06-8203
7,4 mm
3



06-8204
8 mm
4

½

06-8198 - 06-8204
SCHEDE
170 mm



06-8205
2,8 mm
Fig: 0000



06-8206
3,6 mm
000



06-8207
4,4 mm
00



06-8208
5,2 mm
0



06-8209
6,8 mm
1



06-8210
8,5 mm
Fig: 2



06-8211
10 mm
3



06-8212
11,5 mm
4

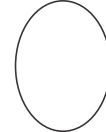

06-8213
13 mm
5



06-8214
14,5 mm
6

½

06-8205 - 06-8214
VOLKMANN
170 mm



06-8215
3,4 mm
Fig: 00







06-8216
5,2 mm
1

½

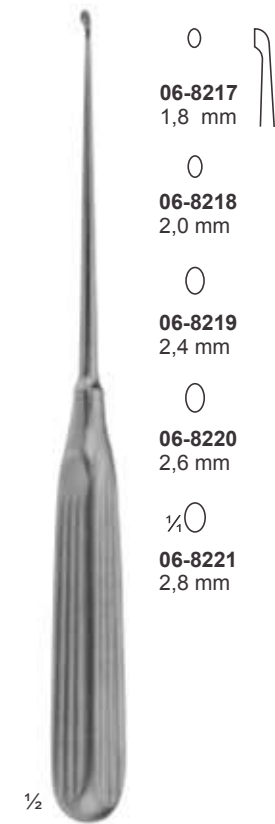
06-8215 - 06-8216
WILLIGER
170 mm



Bone Currettes

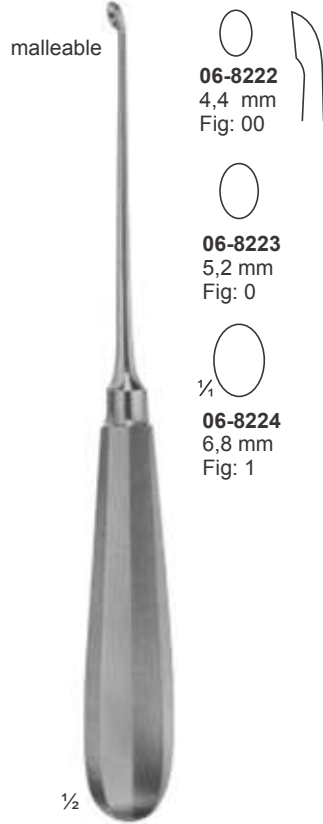

-  **06-8217**
1,8 mm
-  **06-8218**
2,0 mm
-  **06-8219**
2,4 mm
-  **06-8220**
2,6 mm
-  **06-8221**
2,8 mm

06-8217 - 06-8221
LEMPERT
215 mm



- malleable
-  **06-8222**
4,4 mm
Fig: 00
 -  **06-8223**
5,2 mm
Fig: 0
 -  **06-8224**
6,8 mm
Fig: 1

06-8222 - 06-8224
HALLE
215 mm

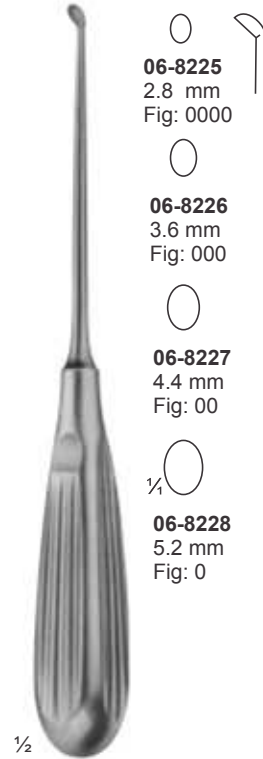

-  **06-8225**
2,8 mm
Fig: 0000
-  **06-8226**
3,6 mm
Fig: 000
-  **06-8227**
4,4 mm
Fig: 00
-  **06-8228**
5,2 mm
Fig: 0

06-8225 - 06-8228
DAUBENSPECK
200 mm



-  **06-8229**
3,6 mm
Fig: 000
-  **06-8230**
4,4 mm
Fig: 00
-  **06-8231**
5,2 mm
Fig: 0
-  **06-8232**
6,8 mm
Fig: 1

06-8229 - 06-8232
250 mm



-  **06-8233**
3,6 mm
Fig: 000
-  **06-8234**
4,4 mm
Fig: 00
-  **06-8235**
5,2 mm
Fig: 0
-  **06-8236**
6,8 mm
Fig: 1

06-8233 - 06-8236
250 mm



-  **06-8237**
3 mm
-  **06-8238**
4 mm
-  **06-8239**
5 mm

06-8237 - 06-8239
BUSHE 250 mm

Bone Curettes



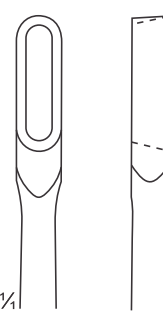

6 mm



1/2

06-8240
TESSIER
220 mm

06-8241
3,6 mm
Fig: 000



06-8242
4,4 mm
Fig: 00



1/4

06-8243
5,2 mm
Fig: 0

1/2

06-8241 - 06-8243
SIMON
235 mm

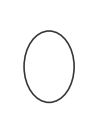
06-8244
6,8 mm
Fig: 1

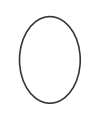

06-8245
8,5 mm
Fig: 2

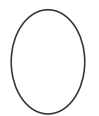

06-8246
10 mm
Fig: 3

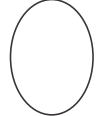

06-8247
11,5 mm
Fig: 4

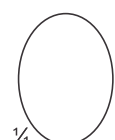

1/4

06-8248
13 mm
Fig: 5



06-8249
14,5 mm
Fig: 6

1/2

06-8244 - 06-8249
SIMON
240 mm

06-8250
3,6 mm
Fig: 000



06-8251
4,4 mm
Fig: 00



1/4

06-8252
5,2 mm
Fig: 0

1/2

06-8250 - 06-8252
CASPAR
220 mm

06-8253
3,6 mm
Fig: 000



06-8254
4,4 mm
Fig: 00





1/4

06-8255
5,2 mm
Fig: 0

1/2

06-8253 - 06-8255
CASPAR
220 mm

06-8256
4 mm

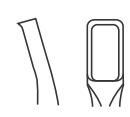

06-8257
5 mm



1/4

06-8258
6 mm

1/2

06-8256 - 06-8258
CASPAR
toothed
220 mm

Bone Currettes With Hartpress Handle

can be sterilized in a steam sterilizer upto 3 bar over pressure (143°C).

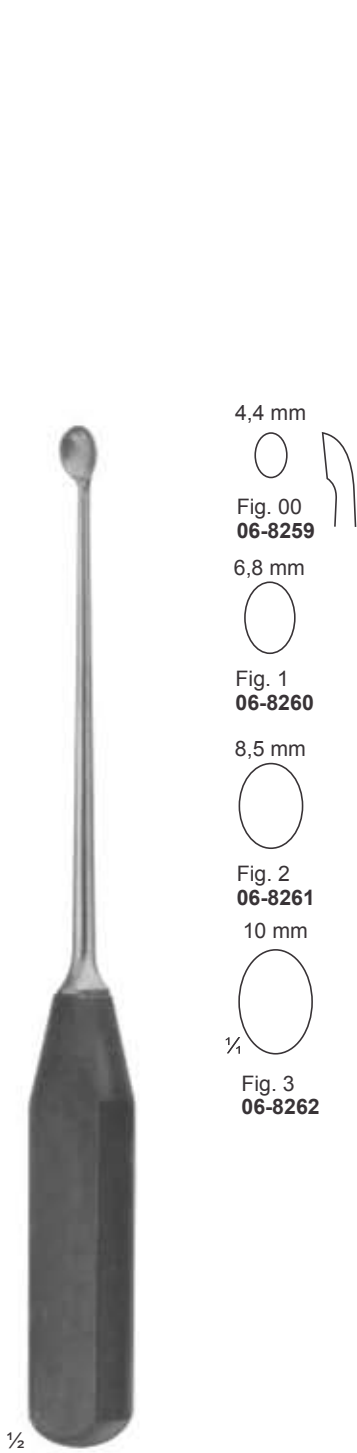

06-8259 - 06-8262
270 mm

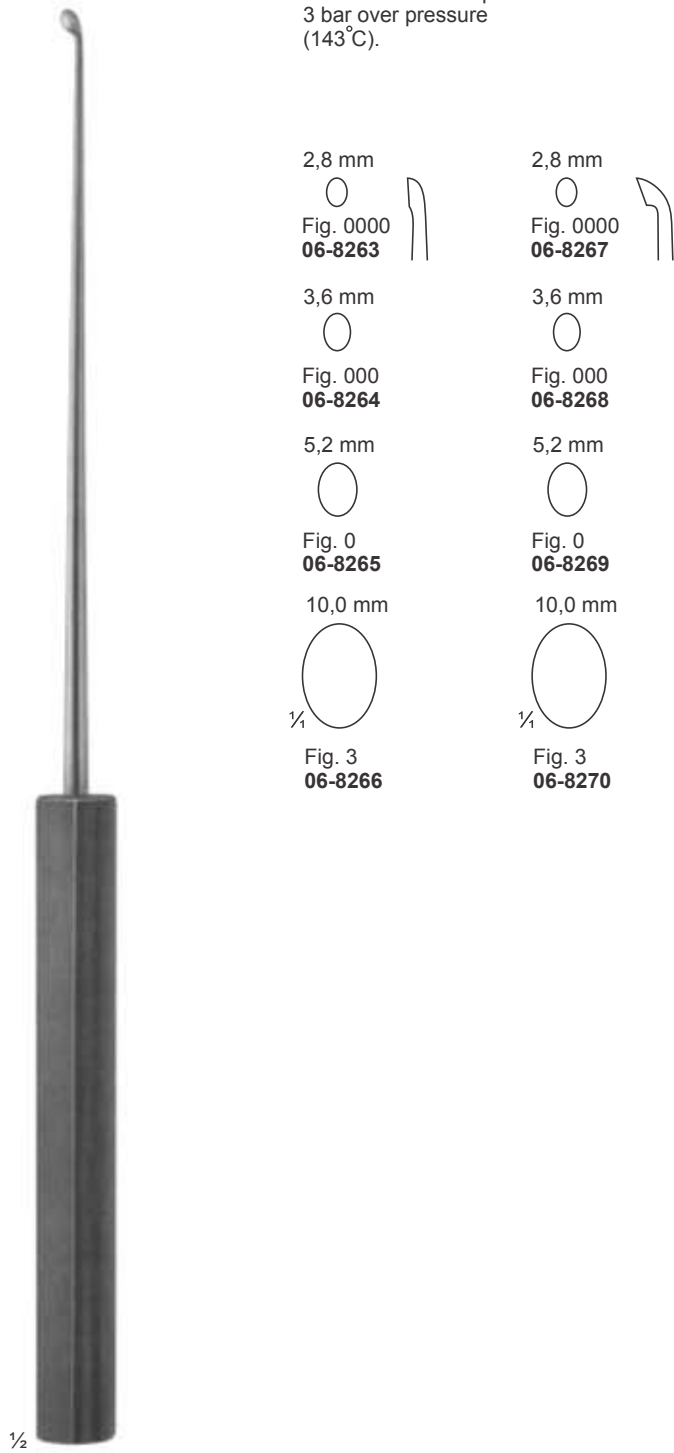

06-8263 - 06-8270
SYPERT
380 mm

Mallets Weight Refer To The Heads Of The Mallets



∅20 mm

½

06-8271
MEAD
185 g
with interchangeable
plastic disks
190 mm
06-8272
pair of spare disks



∅25 mm

½

06-8273
140 g
with interchangeable
plastic disks
185 mm
06-8274
pair of spare disks



∅30 mm

½

06-8275
COTTLE
240 g
1 Side flat
1 Side convex
185 mm



∅22 mm

½

06-8276
165 g
lead filled head
190 mm

Mallets, Weights Refer To The Heads Of The Mall



06-8277
HAJEK
140 g
220 mm



06-8278
215 g
with interchangeable
plastic disks
245 mm
06-8279
pair of spare disks



06-8280 - 06-8283
WAGNER
complete with:
1 pair of metal disks (**06-8281**) and
1 pair of plastic disks (**06-8282**) and
1 wrench (**06-8283**)
235 mm

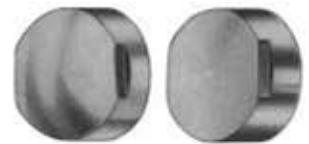

06-8281 230g
1 metal disk, flat
1 metal disk, convex



06-8282 32g
1 plastic disk, flat
1 plastic disk, convex



06-8283
Wrench

Mallets Weight Refer To The Heads Of The Mallets



1/2
06-8284 300g
BERGMANN
245 mm



1/2
06-8285 300g
BERGMANN
235 mm



1/2
06-8286 550g
OMBREDANNE
240 mm

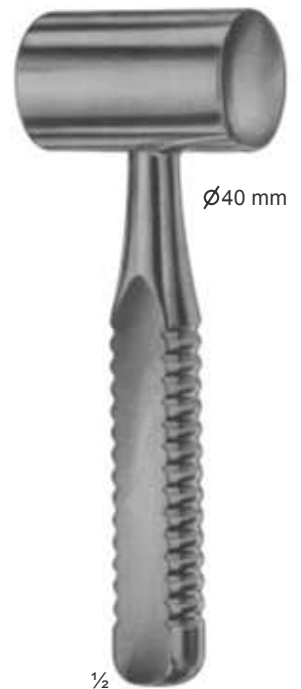

1/2
06-8287
HEATH
copper filled head
700 g
185 mm

Tampers - Osteotomes, Chisels and Gouges

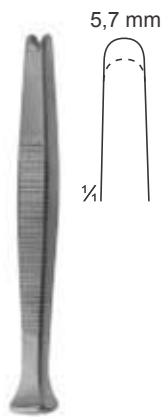

06-8288
HAASE
100 mm



06-8289 - 06-8290
PASSOW
120 mm



06-8291 - 06-8293
CASPAR
200 mm



06-8294 - 06-8296
200 mm

- **06-8291**
ø 3 mm
- **06-8292**
ø 5 mm
- **06-8293**
ø 8 mm

- **06-8294**
ø 12 mm
- **06-8295**
ø 14 mm
- **06-8296**
ø 16 mm

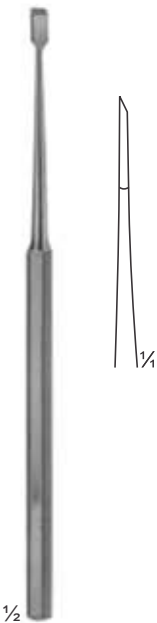

06-8297 4mm
FREER
Chisel
160 mm

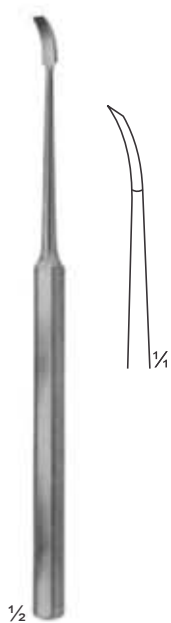

06-8298 4mm
FREER
Chisel, curved
160 mm

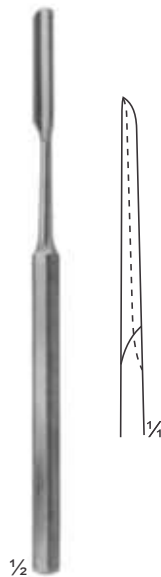

06-8299 6mm
FREER
Gouge
150 mm

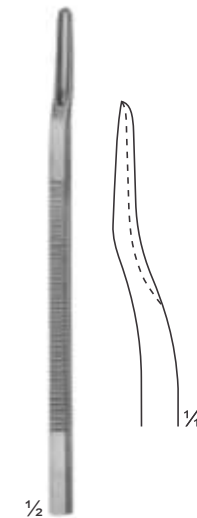

06-8300 3.4mm
Scaphoid gouge,
downwards curved
135 mm

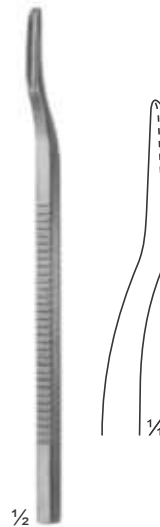

06-8301 3.4mm
Scaphoid gouge,
upwards curved
135 mm

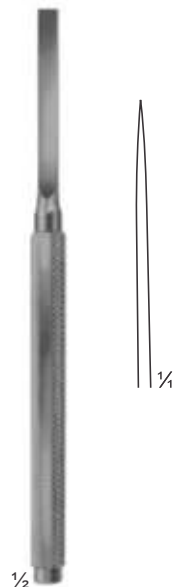

06-8302 - 06-8304
MANNERFELT modif
Osteotomes
06-8302 4 mm
06-8303 6 mm
06-8304 8 mm
155 mm

Osteotomes Chisels and Gouges

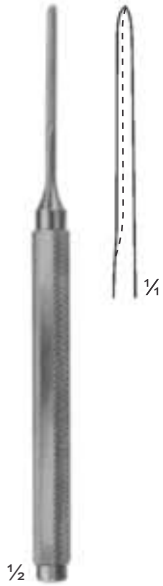

06-8305 3mm
MANNERFELT modif.
Gouge
155 mm

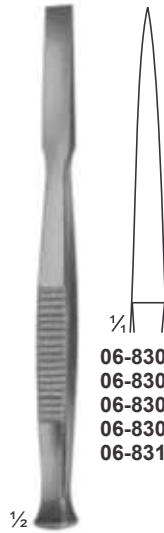

06-8306 4 mm
06-8307 6 mm
06-8308 8 mm
06-8309 10 mm
06-8310 12 mm

06-8306 - 06-8310
Osteotomes
140 mm

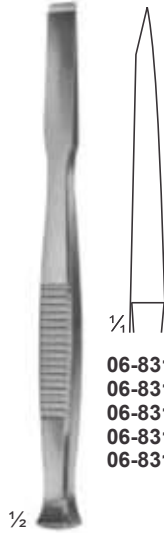

06-8311 4 mm
06-8312 6 mm
06-8313 8 mm
06-8314 10 mm
06-8315 12 mm

06-8311 - 06-8315
Chisels
140 mm

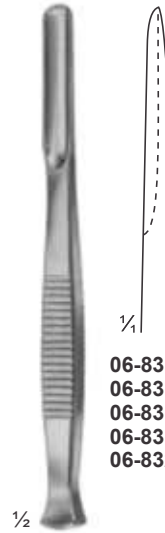

06-8316 4 mm
06-8317 6 mm
06-8318 8 mm
06-8319 10 mm
06-8320 12 mm

06-8316 - 06-8320
Gouges
140 mm

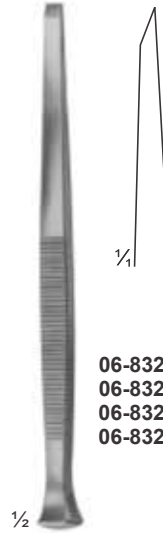

06-8321 3 mm
06-8322 4 mm
06-8323 5 mm
06-8324 6 mm

PARTSCH
06-8321 - 06-8324
Chisels
140 mm

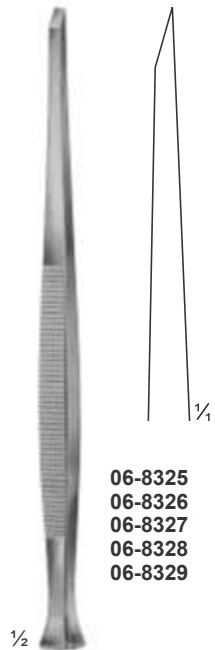

06-8325 3 mm
06-8326 4 mm
06-8327 5 mm
06-8328 6 mm
06-8329 7 mm

PARTSCH
06-8325 - 06-8329
Chisels
170 mm

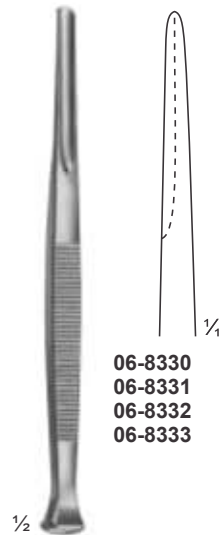

06-8330 3 mm
06-8331 4 mm
06-8332 5 mm
06-8333 6 mm

PARTSCH
06-8330 - 06-8333
Gouges
140 mm

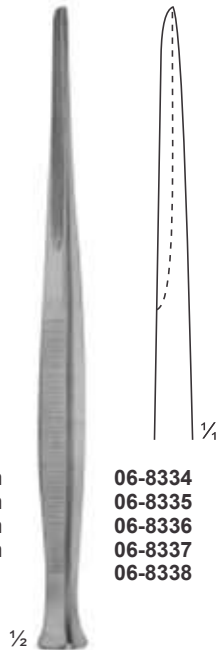

06-8334 3 mm
06-8335 4 mm
06-8336 5 mm
06-8337 6 mm
06-8338 7 mm

PARTSCH
06-8334 - 06-8338
Gouges
170 mm



06-8339 4 mm
06-8340 6 mm

LUCAS
06-8339 - 06-8340
Chisels
160 mm

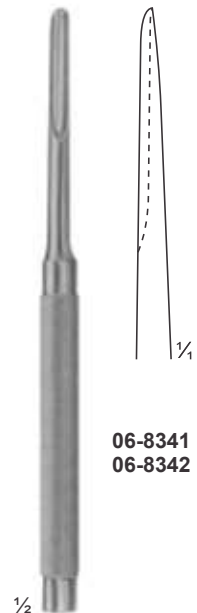

06-8341 3 mm
06-8342 5 mm

LUCAS
06-8341 - 06-8342
Gouges
160 mm

Osteotomes Chisels and Gouges

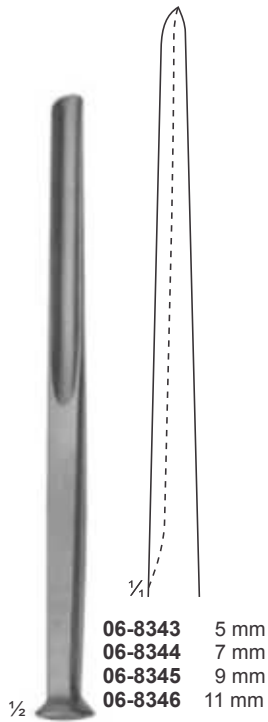

- 06-8343 5 mm
- 06-8344 7 mm
- 06-8345 9 mm
- 06-8346 11 mm

ALEXANDER
06-8343 - 06-8346
Gouges
170 mm

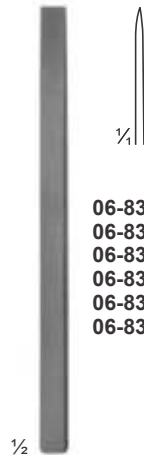

- 06-8347 4 mm
- 06-8348 6 mm
- 06-8349 8 mm
- 06-8350 10 mm
- 06-8351 12 mm
- 06-8352 15 mm

LAMBOTTE
06-8347 - 06-8352
Osteotomes
125 mm

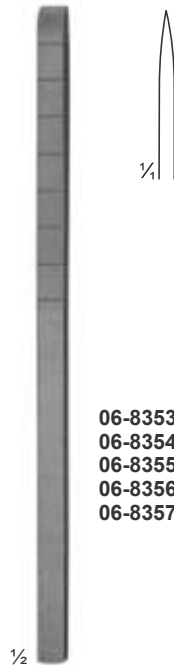

- 06-8353 4 mm
- 06-8354 6 mm
- 06-8355 8 mm
- 06-8356 10 mm
- 06-8357 12 mm

COTTLE
06-8353 - 06-8357
Osteotomes with depth
markings
180 mm

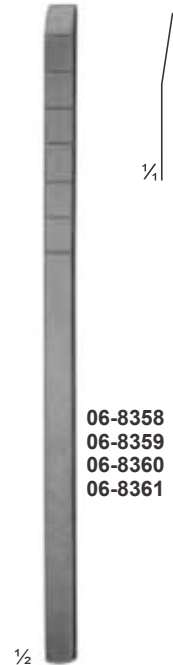

- 06-8358 4 mm
- 06-8359 7 mm
- 06-8360 9 mm
- 06-8361 12 mm

COTTLE
06-8358 - 06-8361
Chisel-Osteotomes
with depth markings
180 mm



COTTLE
06-8362 8mm
Fishtail Chisel,
with protected ends
180 mm

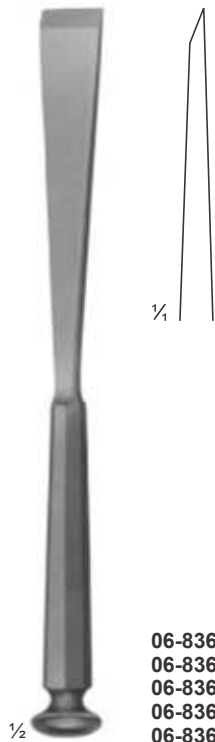

- 06-8363 10 mm
- 06-8364 12 mm
- 06-8365 15 mm
- 06-8366 20 mm
- 06-8367 25 mm

STILLE
06-8363 - 06-8367
Chisels
205 mm

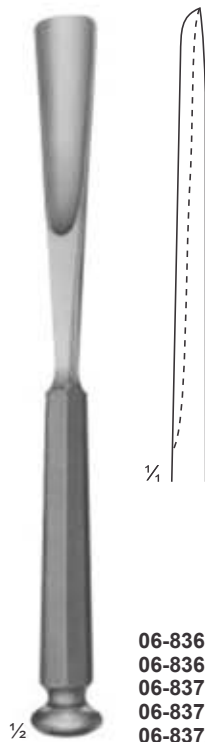

- 06-8368 10 mm
- 06-8369 12 mm
- 06-8370 15 mm
- 06-8371 20 mm
- 06-8372 25 mm

STILLE
06-8368 - 06-8372
Gouges
205 mm

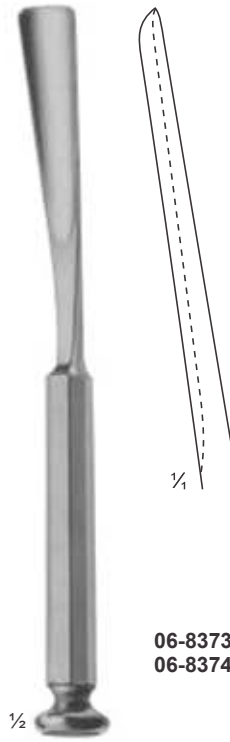

- 06-8373 10 mm
- 06-8374 15 mm

WALTER
06-8373 - 06-8374
gouges for taking
grafts from the ribs
205 mm



- 06-8375 8mm
- 06-8376 10 mm
- 06-8377 12 mm
- 06-8378 15 mm
- 06-8379 20 mm
- 06-8380 25 mm

STILLE
06-8375 - 06-8380
Osteotomes
205 mm

Osteotomes



www.smsindus.com

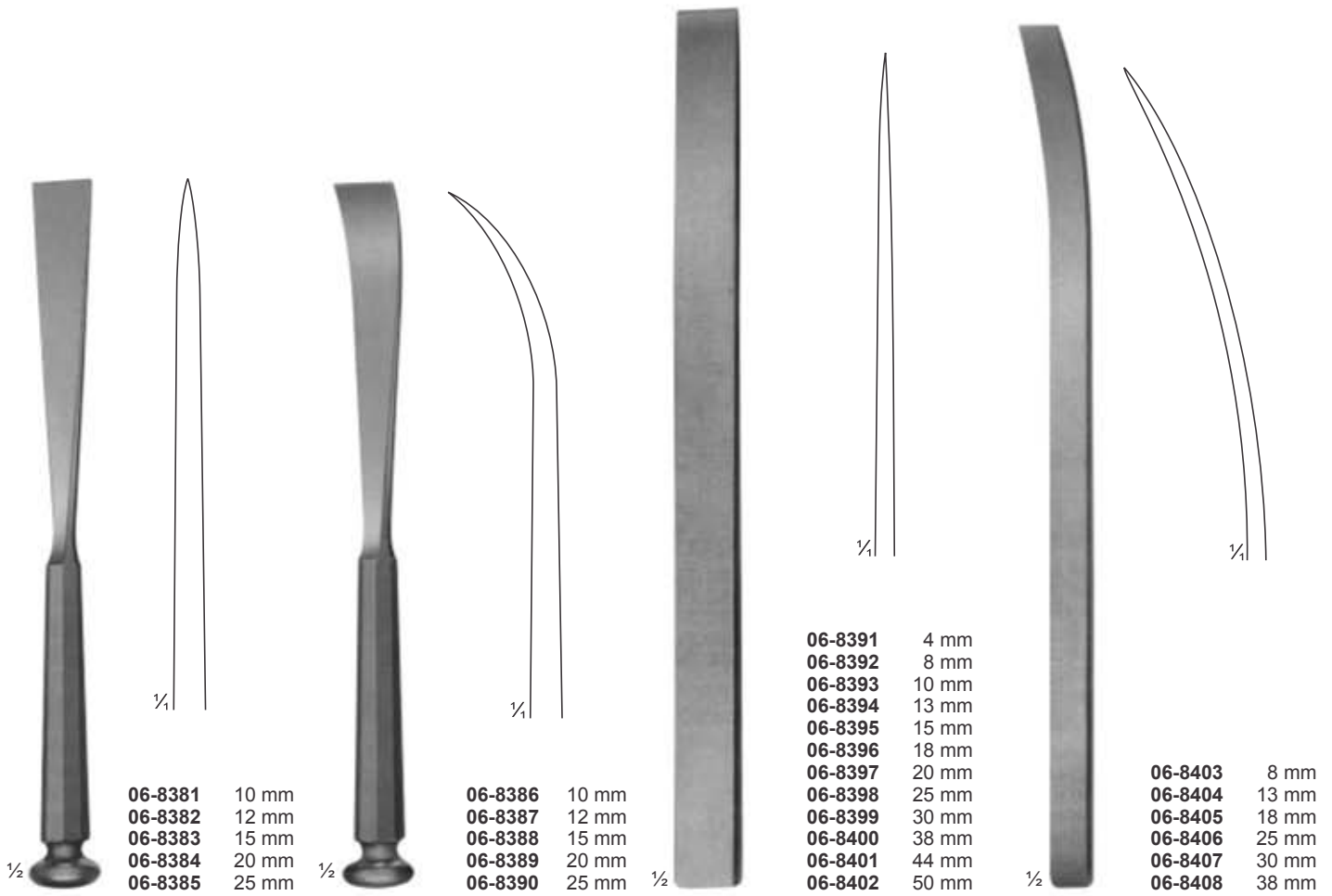

STILLE
06-8381 - 06-8385
Osteotomes
205 mm

STILLE
06-8386 - 06-8390
Osteotomes, curved
205 mm

LAMBOTTE
06-8391 - 06-8402
Osteotomes
245 mm

LAMBOTTE
06-8403 - 06-8408
Osteotomes, curved
245 mm

Osteotomes, Chisels and Gouges with HARTPRESS -handle



- 06-8409 4 mm
- 06-8410 6 mm
- 06-8411 8 mm
- 06-8412 10 mm
- 06-8413 12 mm

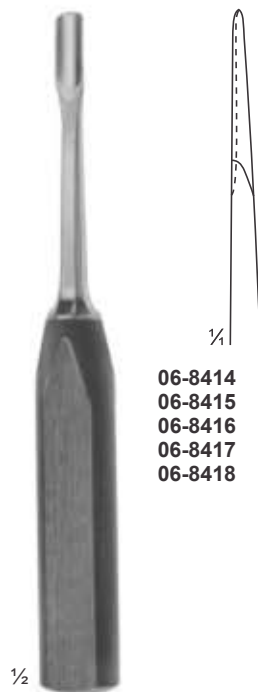

- 06-8414 4 mm
- 06-8415 6 mm
- 06-8416 8 mm
- 06-8417 10 mm
- 06-8418 12 mm



- 06-8419 5 mm
- 06-8420 7 mm
- 06-8421 10 mm
- 06-8422 15 mm
- 06-8423 20 mm
- 06-8424 25 mm
- 06-8425 30 mm

LEXER-MINI
06-8409 - 06-8413
Osteotomes
180 mm

LEXER-MINI
06-8414 - 06-8418
Gouges
180 mm

LEXER
06-8419 - 06-8425
Gouges
220 mm



- 06-8426 5 mm
- 06-8427 7 mm
- 06-8428 10 mm
- 06-8429 15 mm
- 06-8430 20 mm
- 06-8431 25 mm
- 06-8432 30 mm

LEXER
06-8426 - 06-8432
Osteotomes
220 mm



06-8433 9mm
Gouge for
removing broken
screws
220 mm



- 06-8434 5,5 mm
- 06-8435 9,0 mm

ZIELKE
06-8434 - 06-8435
Gouges for
scoliosis-operations
230 mm

Osteotomes ,Chisels and Gouges with HARTPRESS -handle

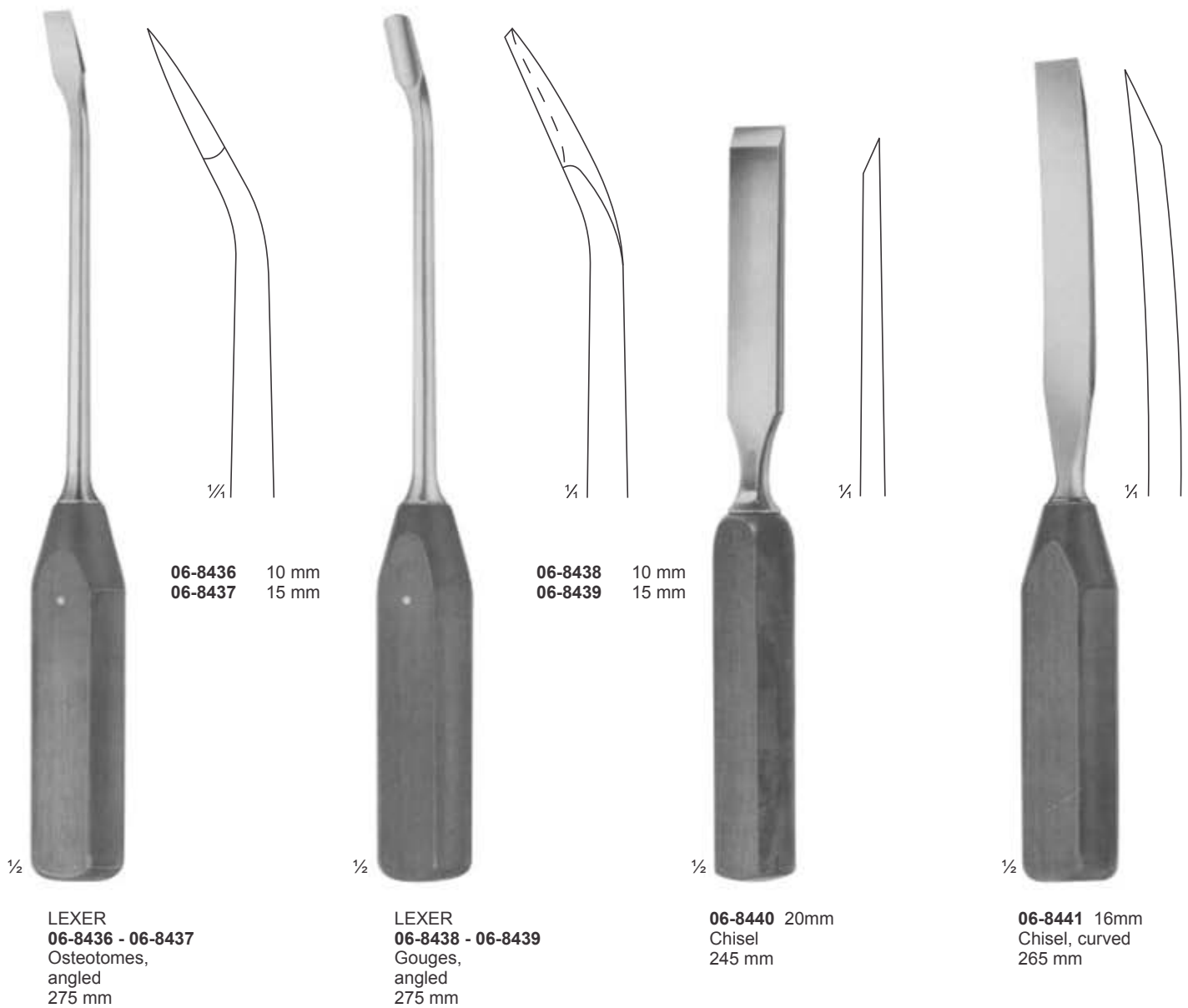

Reposition Forceps



06-8442
Reposition forceps,
for small fragments
135 mm

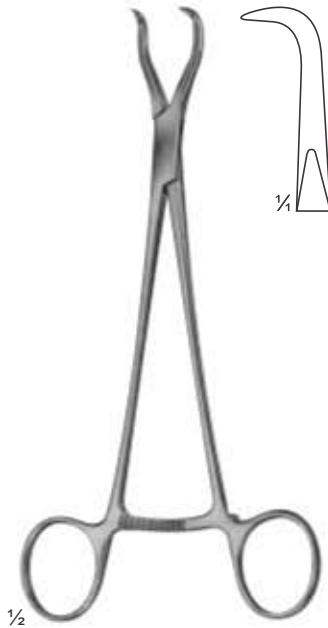

06-8443
HAASE
Reposition forceps,
for mandibular
fractures
165 mm

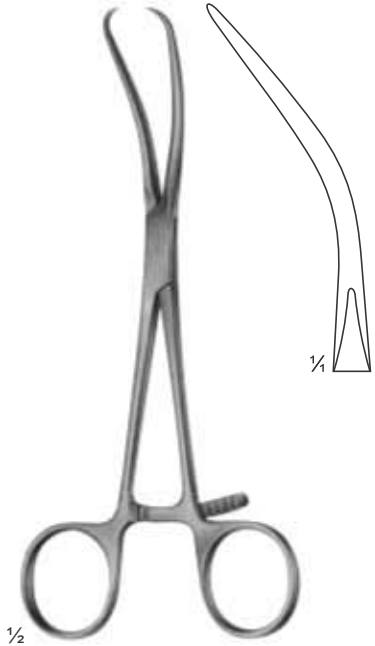

06-8444
REILL
Reposition forceps,
170 mm



06-8445
Reposition forceps
205 mm

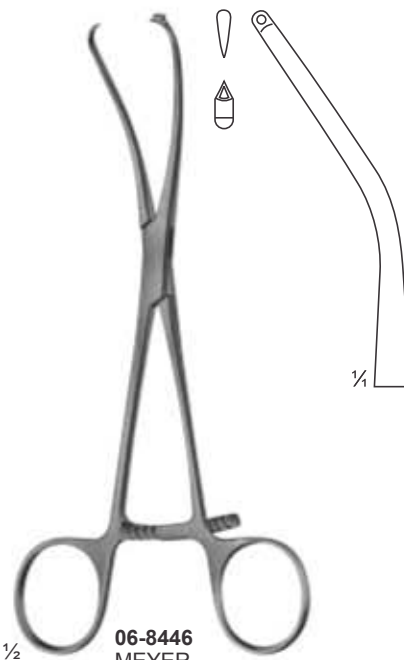

06-8446
MEYER
Reposition forceps
for fingers, with drill
guide for KIRSCHNER
wires up to daim.1.0 mm
170 mm

Reposition Forceps, Bone Holding Forceps



06-8447
Patella forceps
185 mm



06-8448
Forceps with
ratchet fixation
140 mm



06-8449
Forceps with
thread fixation
170 mm



06-8450
Forceps with
thread fixation
235 mm

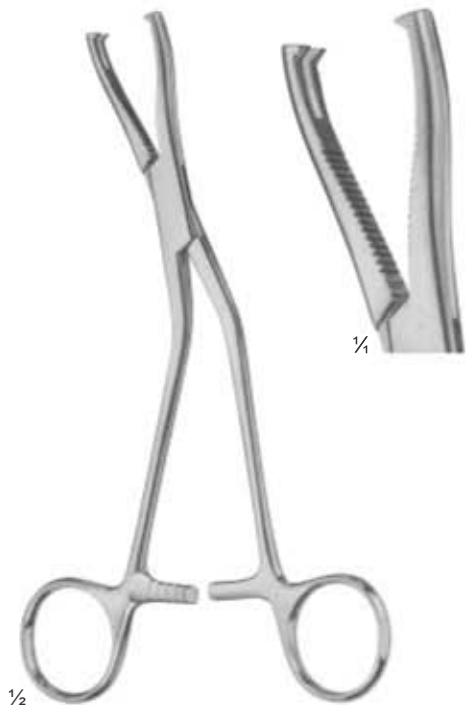

06-8451
DINGMANN modif
185 mm

Bone Holding Forceps



06-8452
Sequestrum
forceps
200 mm



06-8453
VAN BUREN
Sequestrum
forceps
225 mm



06-8454
LANGENBECK
205 mm



06-8455
FERGUSSON
205 mm

Bone Holding Forceps

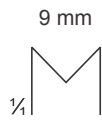
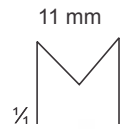
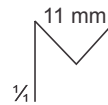
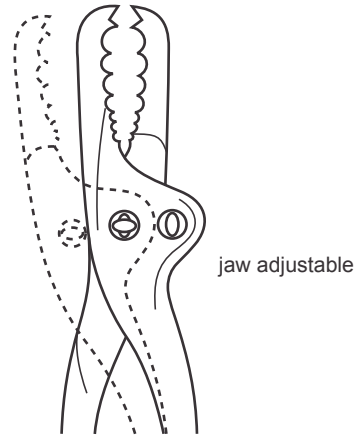

8 mm



06-8456
SEMB
190 mm



06-8457
FARABEU
230 mm



06-8458
FARABEU
255 mm



06-8459
FARABEU-LAMBOTTE
255 mm

Bone Holding Forceps

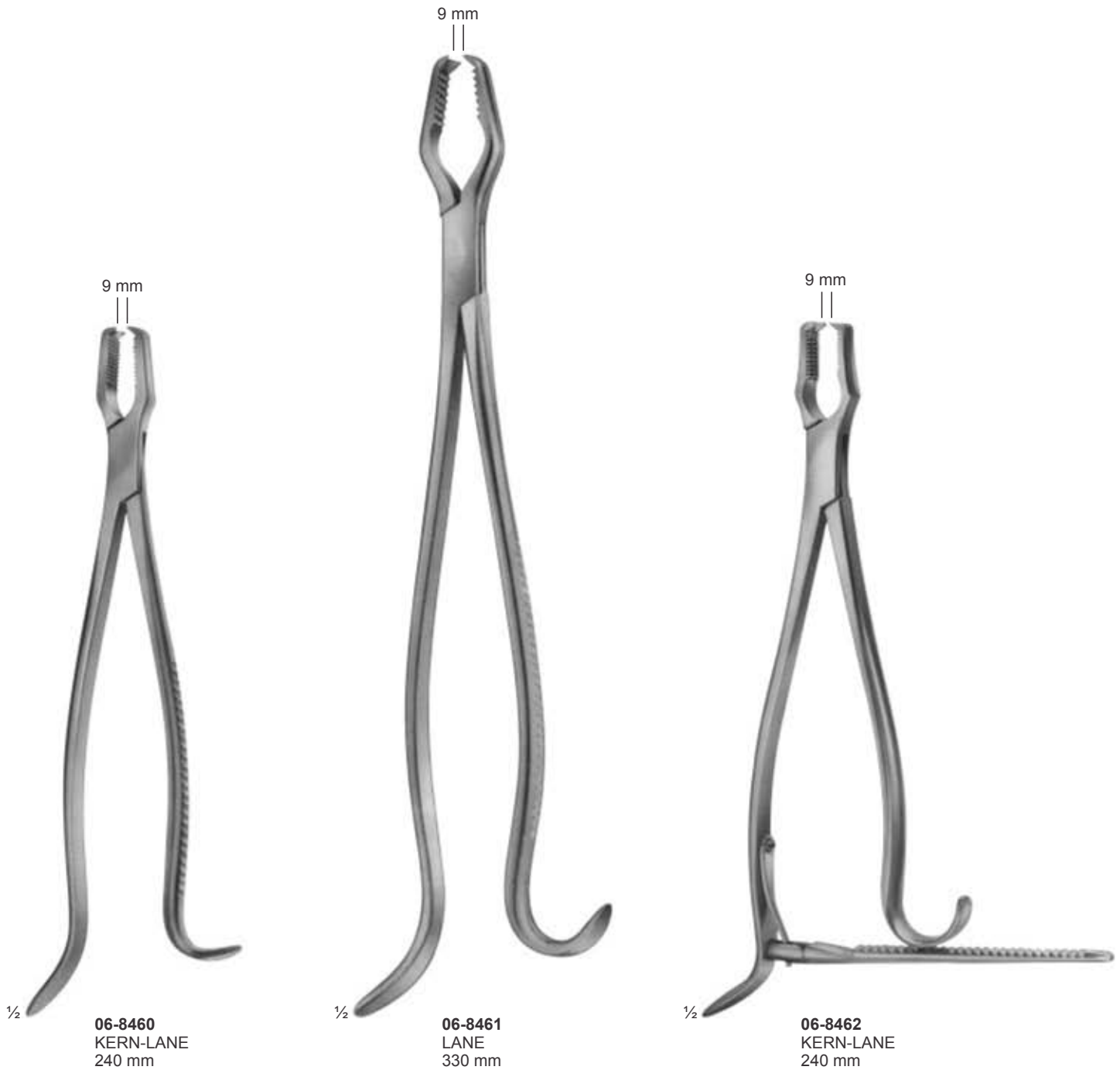

Bone Holding Forceps



www.smsindus.com



06-8463
LANE
320 mm



06-8464
HEY GROVES
305 mm

Bone Holding Forceps

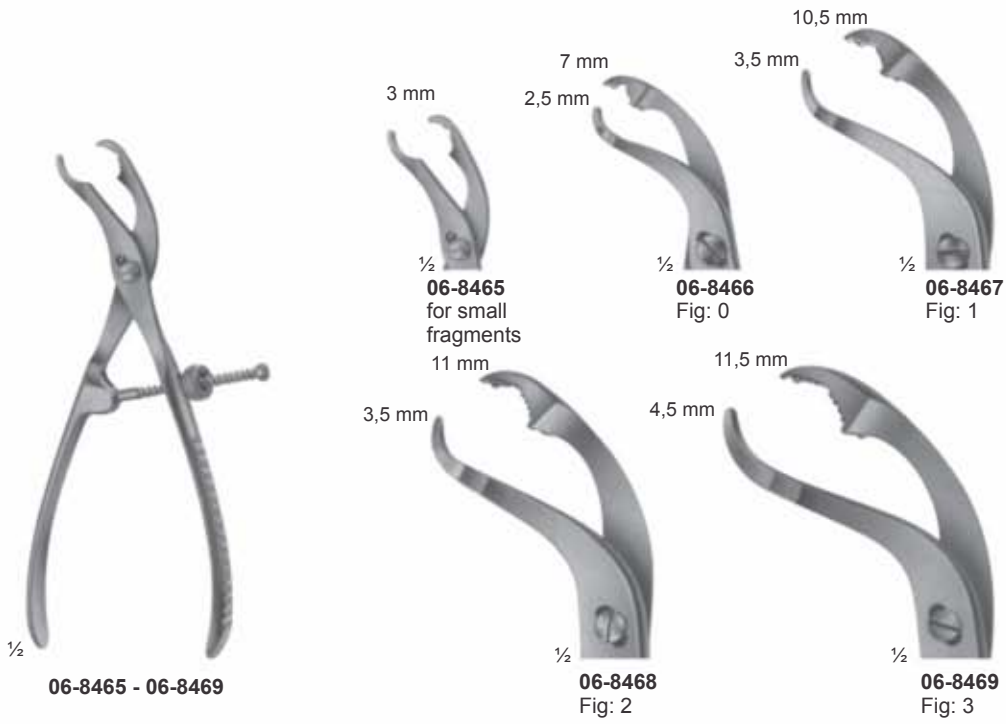

- 06-8465** 145 mm
- 06-8466** 190 mm
- 06-8467** 240 mm
- 06-8468** 260 mm
- 06-8469** 280 mm

Self-centering forceps
with thread fixation

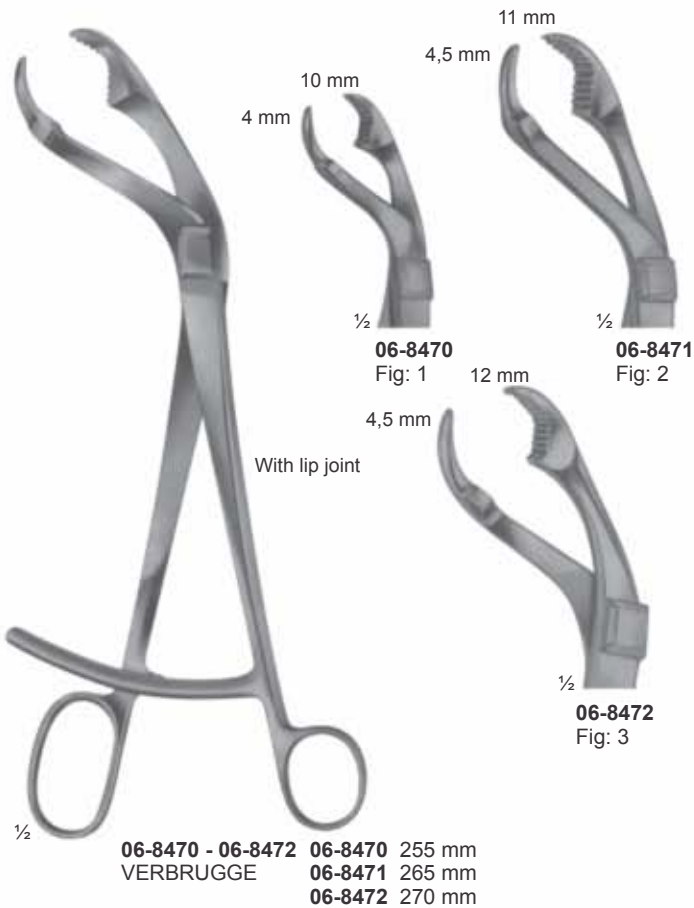

- 06-8470 - 06-8472** **06-8470** 255 mm
- VERBRUGGE** **06-8471** 265 mm
- 06-8472** 270 mm



- 06-8473** **LAMBOTTE** 265 mm

Bone Clamps



½

06-8474 - 06-8475
LOWMAN
06-8474 170 mm
06-8475 205 mm



½

06-8476
LOWMAN-GERSTER
210 mm



½

06-8477
LOWMAN-HOGLUND
175 mm

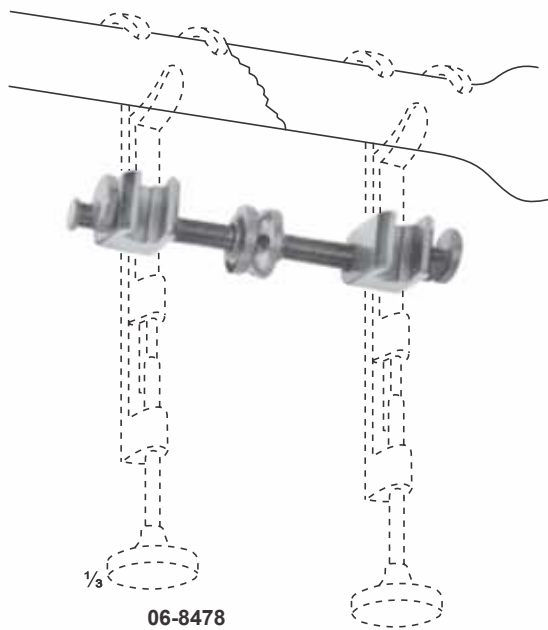

⅓

06-8478
GERSTER
Traction bar for **06-8474 - 06-8477**

Synovectomy-Rongeurs, Bone Rongeurs



06-8479 - 06-8480
Synovectomy rongeur
width of jaws 1.2 mm
130 mm



06-8481 - 06-8482
Synovectomy rongeur
width of jaws 2.0 mm
130 mm

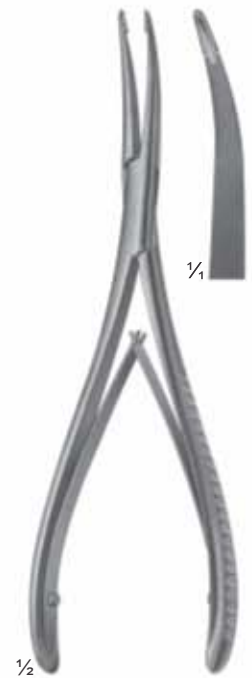

06-8483
STELLBRINK
Synovectomy rongeur
175 mm



06-8484
STELLBRINK
Synovectomy rongeur
170 mm



06-8485
LUER-FRIEDMANN
145 mm



06-8486
140 mm

Bone Rongeurs



06-8487
LUER
150 mm



06-8488
LUER
155 mm



06-8489
BLUMENTHAL
155 mm



06-8490
BLUMENTHAL
150 mm



06-8491 - 06-8492
JANSEN
175 mm

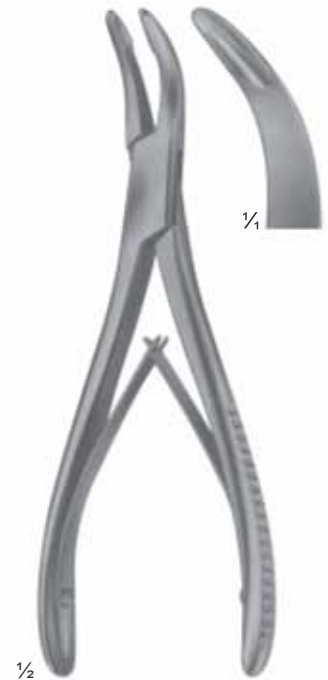

06-8493
BANE-HARTMANN
175 mm

Bone Rongeurs

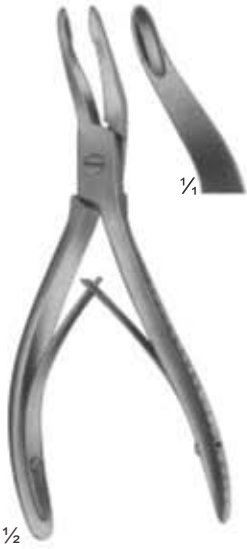

06-8494
ALEXANDER
140 mm

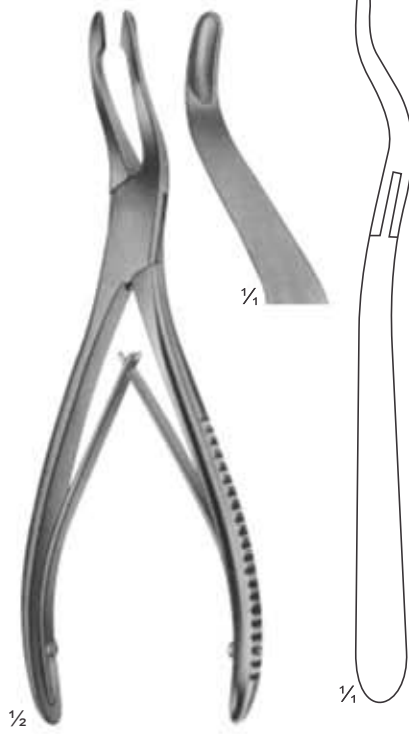

06-8495
JANSEN
190 mm

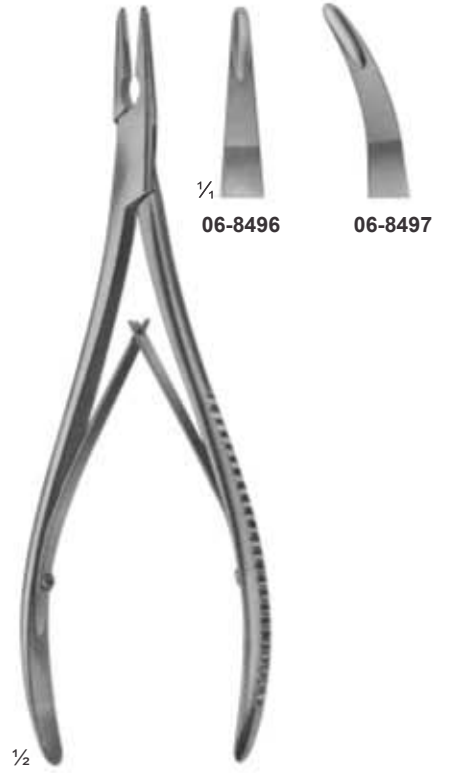

06-8496 - 06-8497
LEMPERT
200 mm

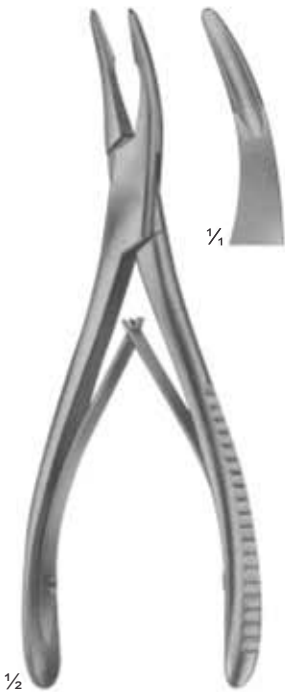

06-8498
BEYER
180 mm



06-8499
MEAD
165 mm

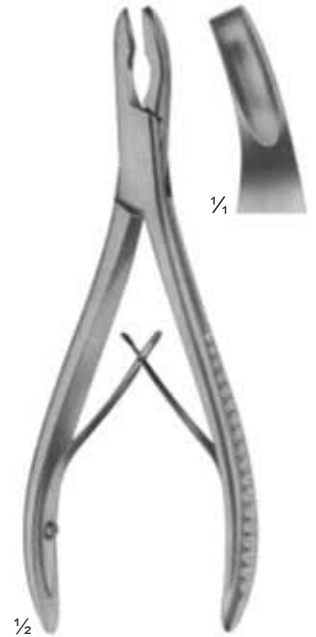

06-8500
MEAD
165 mm

Bone Rongeurs

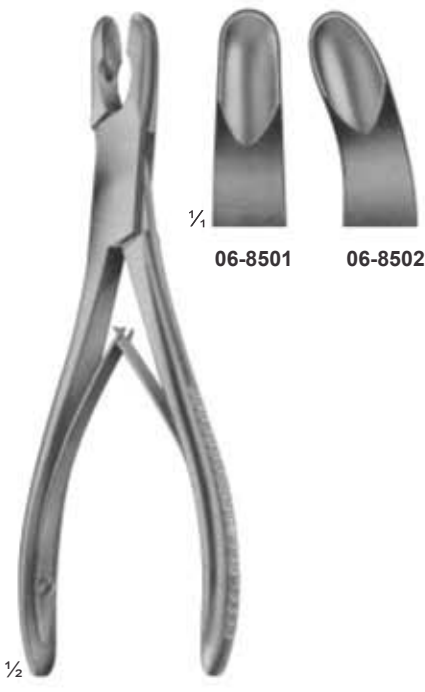

06-8501 06-8502

06-8501 - 06-8502
LUER
175 mm



06-8503
LUER
180 mm



06-8504
LUER
180 mm



06-8505
OLIVECRONA
205 mm



06-8506 - 06-8507
BOHLER
155 mm



06-8508
MARQUARDT
200 mm

Bone Rongeurs



06-8509
RUSKIN
190 mm



06-8510
ROETTGEN-RUSKIN
240 mm



06-8511 - 06-8512
ECHLIN
230 mm

Bone Rongeurs



www.smsindus.com



06-8513
STILLE
235 mm



06-8514
LEKSELL-STILLE
240mm



06-8515
STILLE-RUSKIN
240mm

Bone Rongeurs



06-8516
LUER-STILLE
225 mm



06-8517
LUER-STILLE
225 mm

Bone Rongeurs



06-8518
LUER-STILLE
270 mm



06-8519
SEMB
240 mm

Bone Cutting Forceps

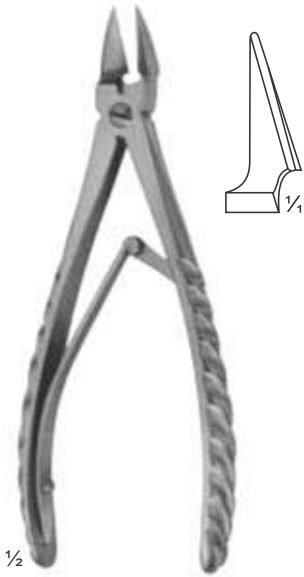

06-8520
STAMM
150 mm



06-8521
KAZANJIAN
185 mm



06-8522 - 06-8525
LISTON



06-8522
140 mm



06-8523
170 mm



06-8524
200 mm

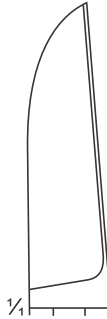

06-8525
220 mm



06-8526 - 06-8528
LISTON



06-8526
170 mm

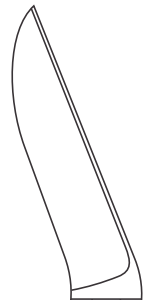

06-8527
200 mm

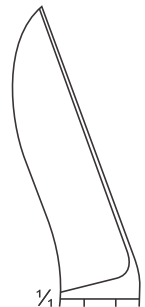

06-8528
220 mm

Bone Cutting Forceps



06-8529
BOEHLER
145 mm

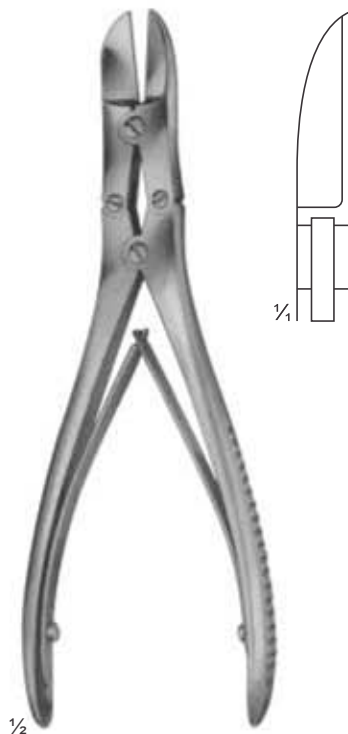

06-8530
RUSKIN-LISTON
190 mm

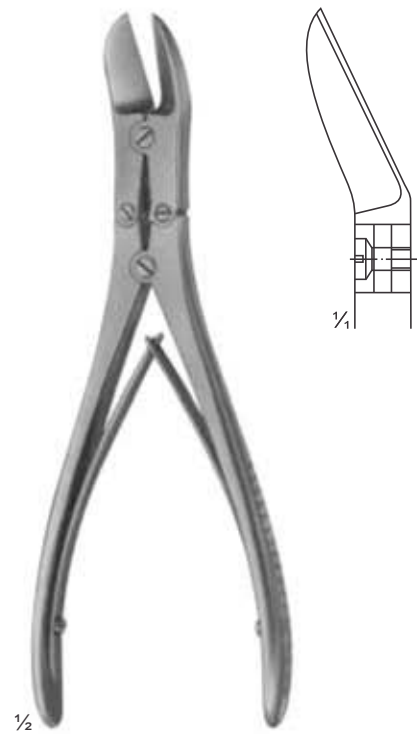

06-8531
RUSKIN-LISTON
190 mm

Bone Cutting Forceps

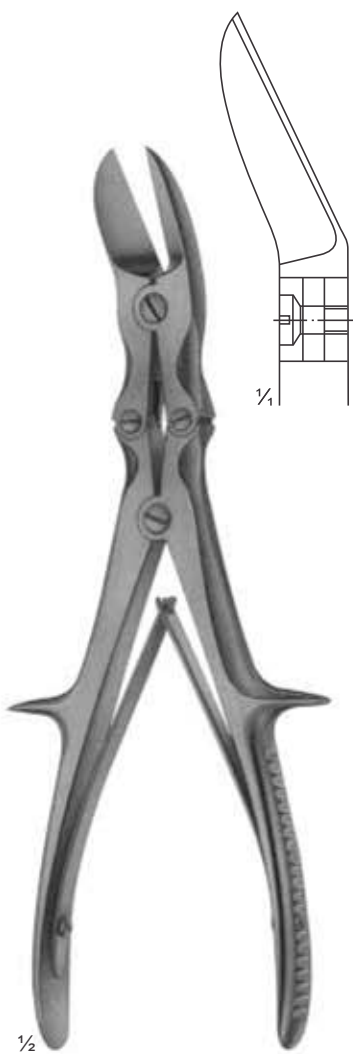

06-8532
LISTON
curved on flat
240 mm

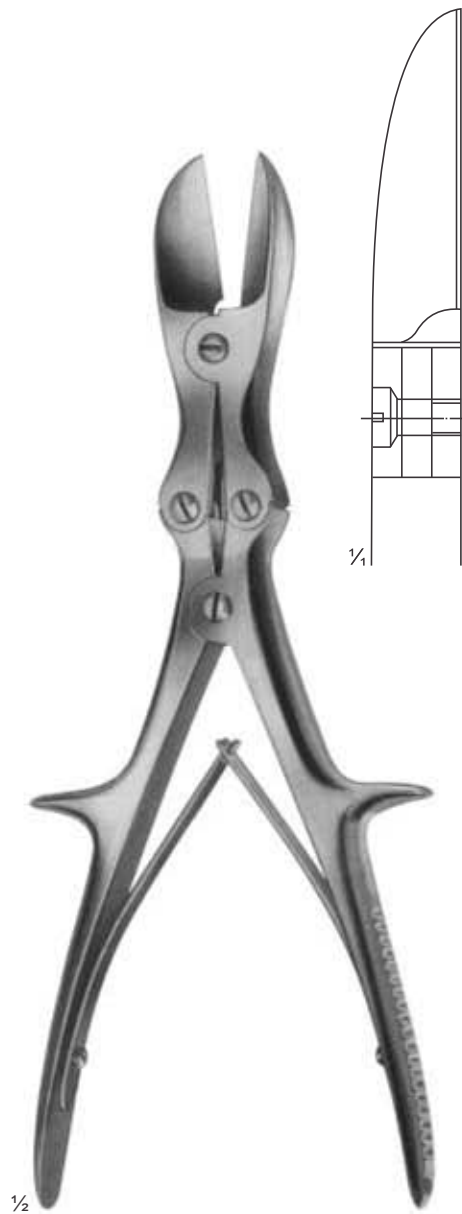

06-8533
LISTON
straight
280 mm

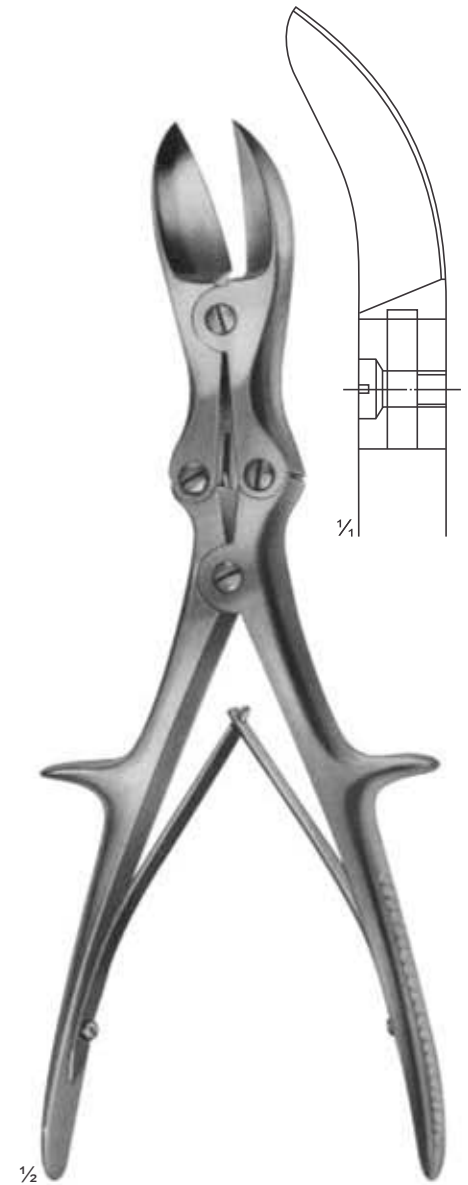

06-8534
LISTON
curved on flat
280 mm

Bone Cutting Forceps

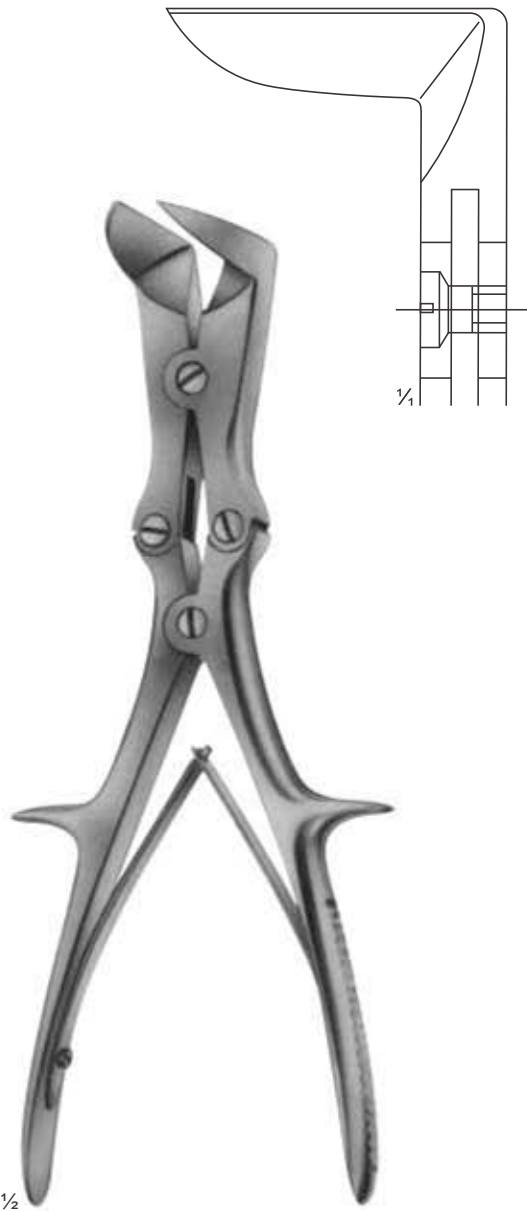

06-8535
LISTON-STILLE
265 mm

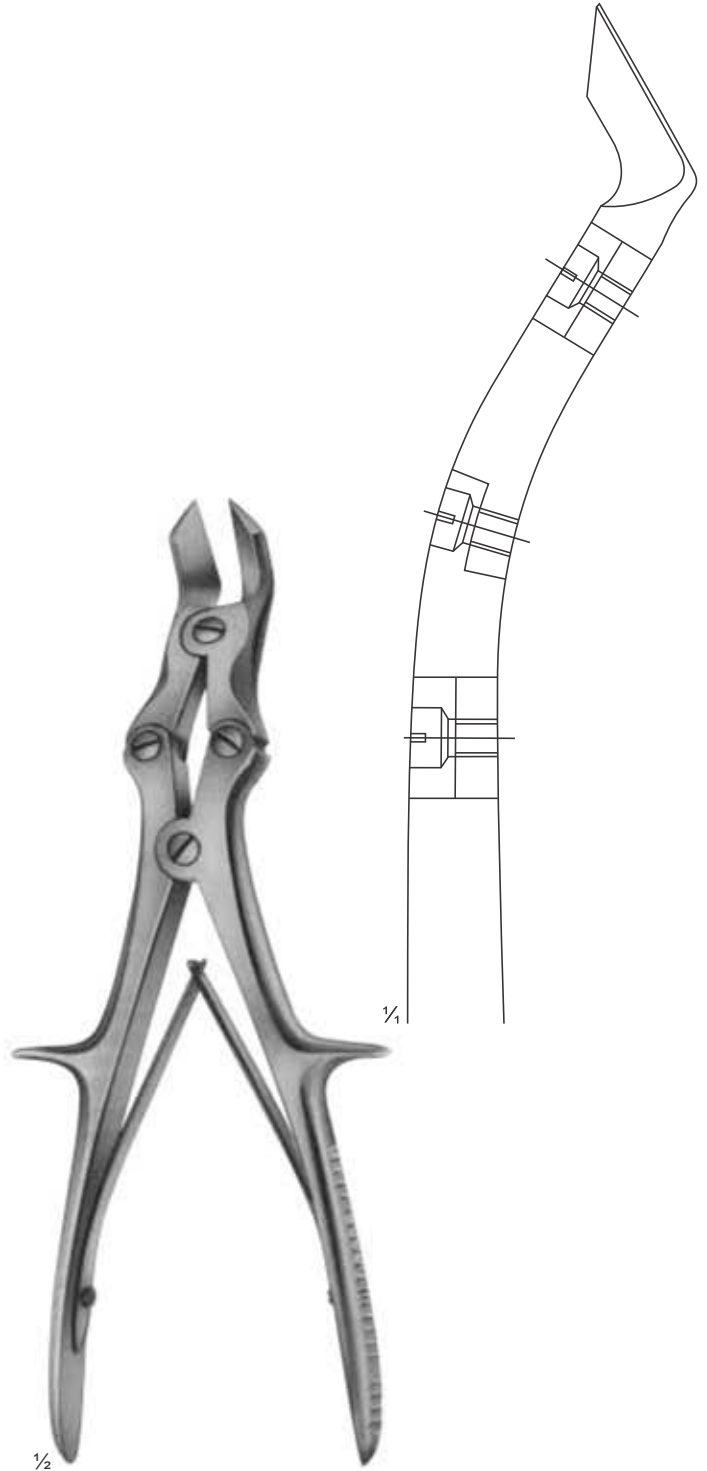

06-8536
LISTON-KEY-HORSLEY
(TUDOR EDWARDS)
255 mm

Meniscus-and Cartilage Forceps

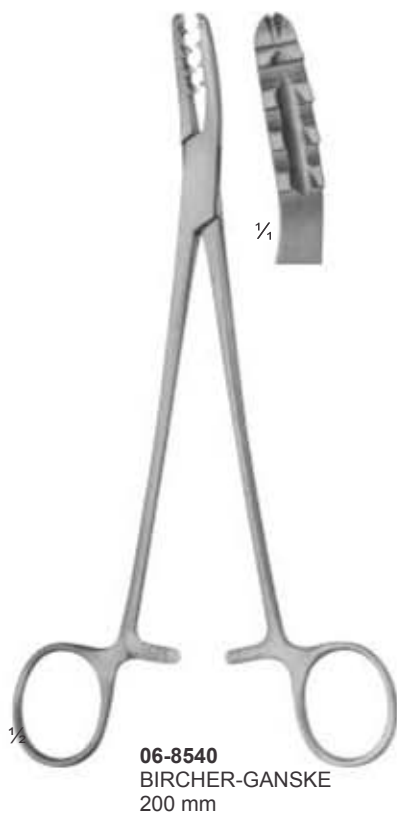

Meniscus Knives



www.smsindus.com

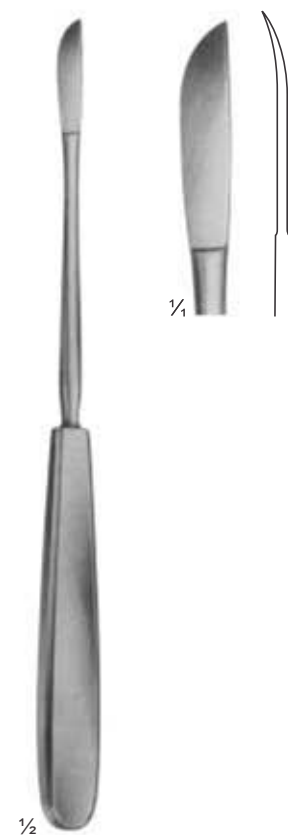
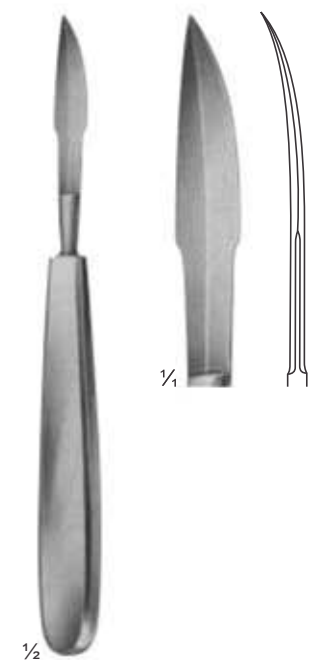

Meniscus Knives



www.smsindus.com

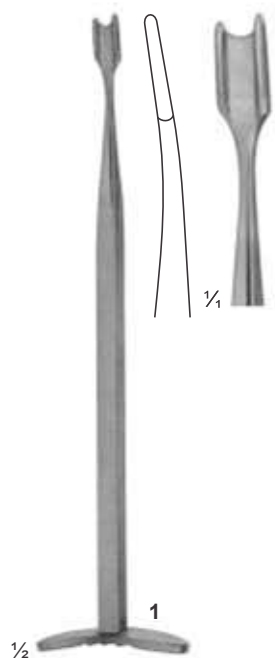

06-8547
SMILLIE
170 mm

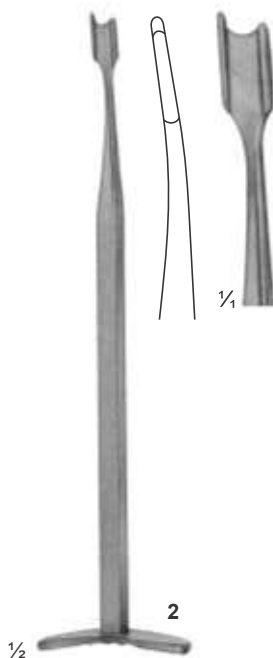

06-8548
SMILLIE
170 mm

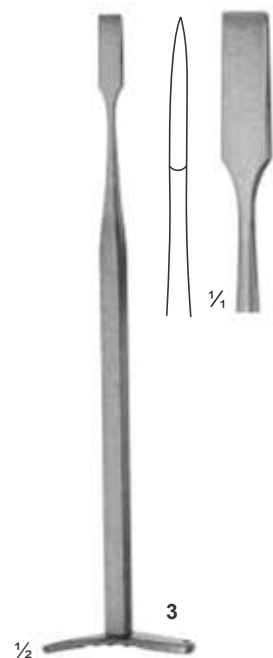

06-8549
SMILLIE
170 mm

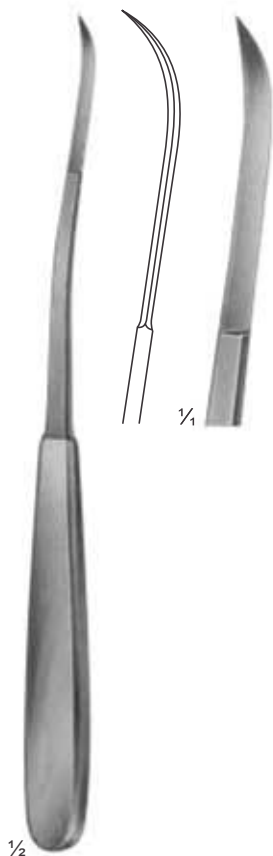

06-8550
SALENIUS
220 mm

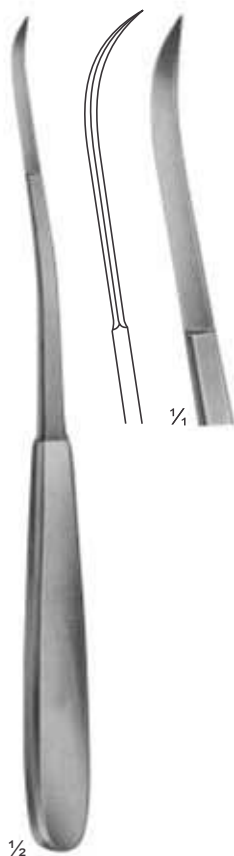

06-8551
SALENIUS
220 mm

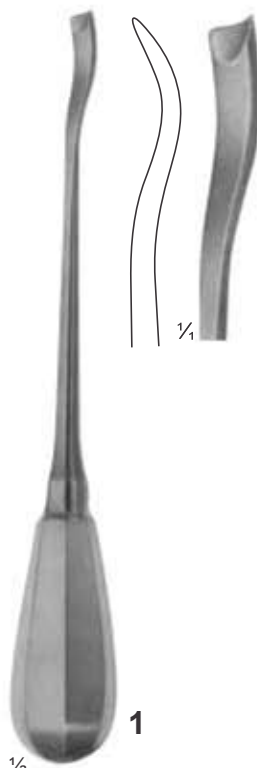

06-8552
CANAD.MODELL
200 mm

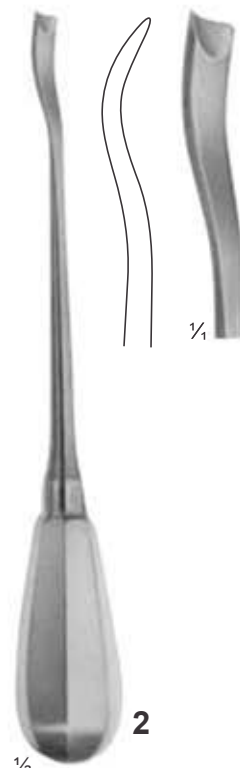

06-8553
CANAD.MODELL
200 mm

Wire Extension

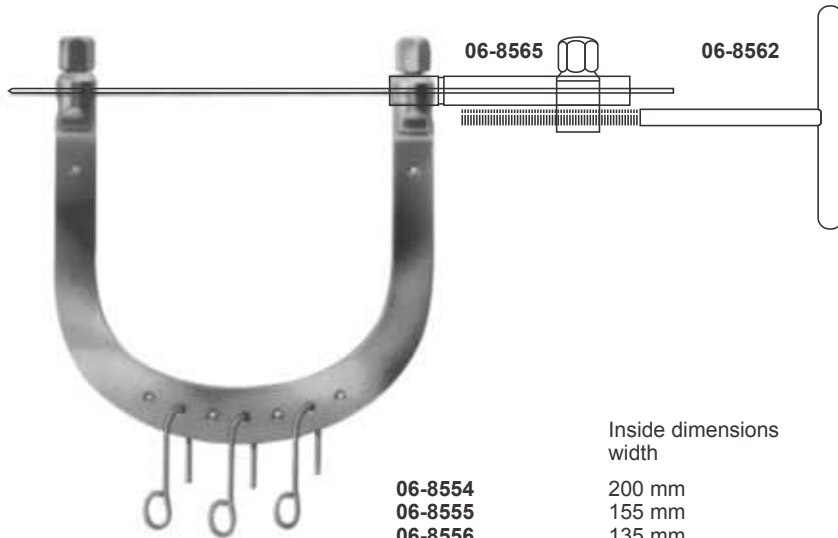

06-8554 - 06-8560
KIRSCHNER
 Wire traction bows,
 to be used with
 KIRSCHNER-wires
 up to 2.5 mm diam.,
 With 3 hooks,
 stainless steel

	Inside dimensions width	depth	
06-8554	200 mm	155 mm	for the hip
06-8555	155 mm	155 mm	for the femur
06-8556	135 mm	130 mm	for the knee
06-8557	120 mm	120 mm	for the knee
06-8558	105 mm	100 mm	for the knee
06-8559	95 mm	110 mm	for the calcaneus
06-8560	95 mm	70 mm	for the arm and elbow



06-8561
 Wrench, double - ended,
 for wire traction bows



06-8562
 Wire tightener, with
 clamping jaws



1/3

06-8563
 Traction hook only,
 large size



1/3

06-8564
 Traction hook only,
 small size



1/3

06-8565
 Fixation clamp, to secure clamping
 jaws of **06-8562** stainless steel

Wire Extension

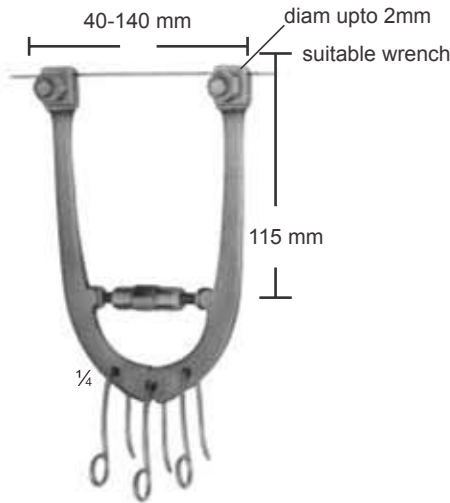

06-8566
Wire traction bow, adjustable,
with 3 hooks, small size

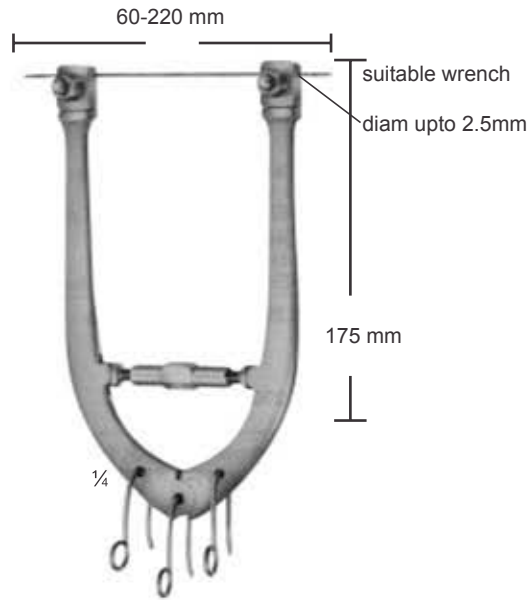

06-8567
Wire traction bow, adjustable,
with 3 hooks, large size

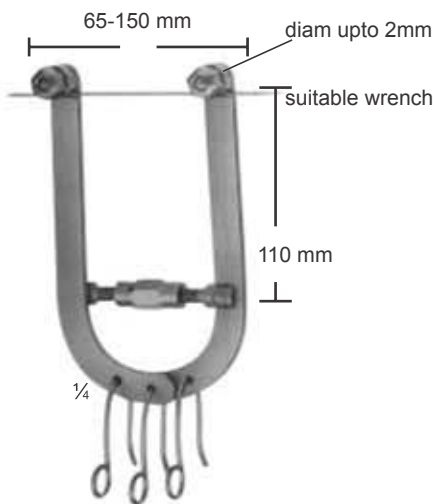

06-8568
Wire traction bow, adjustable,
with 3 hooks, small size for
elbow and calcaneus, for
adolescents

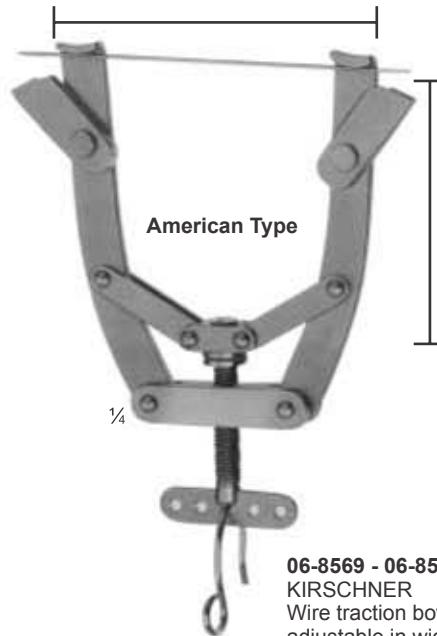

06-8569 max. 105 mm
06-8570 max. 160 mm
06-8571 max. 200 mm

06-8569 80-95 mm
06-8570 90-120 mm
06-8571 140-170 mm

diam upto
06-8569 1,6 mm
06-8570 2,0 mm
06-8571 2,5 mm

06-8569 - 06-8571
KIRSCHNER
Wire traction bows, modified,
adjustable in width, holds wire
securely, with 1 hook



06-8572
Fixation disc, slotted



06-8573
idem, aluminum, transparent
to X-rays



06-8574
Fixation disc, slotted



06-8575
Screw driver, for above
fixations discs

Traction Bows, Distractor



Boehler traction bows, to be used with STEINMANN pins, 4mm diam	Boehler traction bows, to be used with STEINMANN pins, 5mm diam	Inside width	For
06-8576 with pin (09-8588)		16x9cm	Arm
06-8577 without pin	06-8582 without pin		
06-8578 with pin (09-8590)		21x11cm	Femur and knee
06-8579 without pin	06-8583 without pin		
06-8580 with pin (09-8592)		21x15cm	Femur and knee
06-8581 without pin			



06-8584 - 06-8598
STEINMANN
triangular shaft ended and trocar point

diam Ø	4,0 mm	5,0 mm
Length		
80 mm	06-8584	
100 mm	06-8585	
120 mm	06-8586	
140 mm	06-8587	
150 mm	06-8588	06-8594
160 mm	06-8589	
180 mm	06-8590	06-8595
200 mm	06-8591	06-8596
210 mm	06-8592	
250 mm	06-8593	06-8597
300 mm		06-8598



06-8599
SCHWARZ
Traction bow for fingers,
to be used with KIRSCHNER-
wire up to 1.6 mm diam.



06-8600
Small distractor
as a repositioning device for
distraction and compression of small bones,
for wires with 3.0 mm diam.



06-8601
Protection cap
for 4,0 mm STEINMANN Pins



06-8602
Protection cap
for 5,0 mm STEINMANN Pins

Drilling Chucks and Cerclage Wire Tightener



1/2

06-8603
REILL
Drilling chuck,
cannulated,
for shanks from
2.0 - 2.5 mm diam
115 mm



1/2

06-8604
Drilling chuck,
cannulated,
for shanks from
0.8 - 2.0 mm diam
150 mm



1/2

06-8605
Drilling chuck,
cannulated,
for shanks up to
4.5 mm diam
with key
140 mm

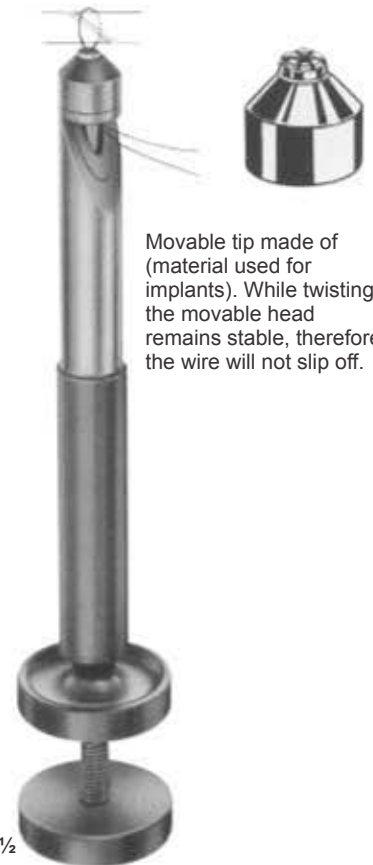

1/2

06-8606
LOUTE
Wire tightener, improved pattern,
with movable tip,
for wires up to 1.0 mm diam.
220 mm

Movable tip made of
(material used for
implants). While twisting
the movable head
remains stable, therefore
the wire will not slip off.

Chuck jaws made of material
used for implants



1/2

06-8607
Drilling chuck, cannulated,
for shanks up to 6.35 mm diam.,
To be tightened by hand
100 mm



1/2

06-8608
Drilling chuck, cannulated,
for shanks up to 4.5 mm diam.,
And for triangular shaft width
across flats 4.7 mm (schanz screws,
steinmann pins). with key **06-8609**

06-8609



1/2

06-8610
Drilling chuck, cannulated,
for shanks up to 6.35 mm diam.,
With key **(06-8611)**
160 mm

06-8611

Cerclage Instruments



www.smsindus.com



06-8612
275 mm

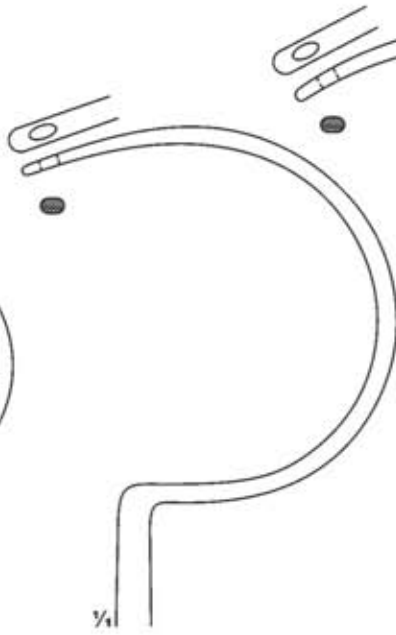

06-8613
285 mm

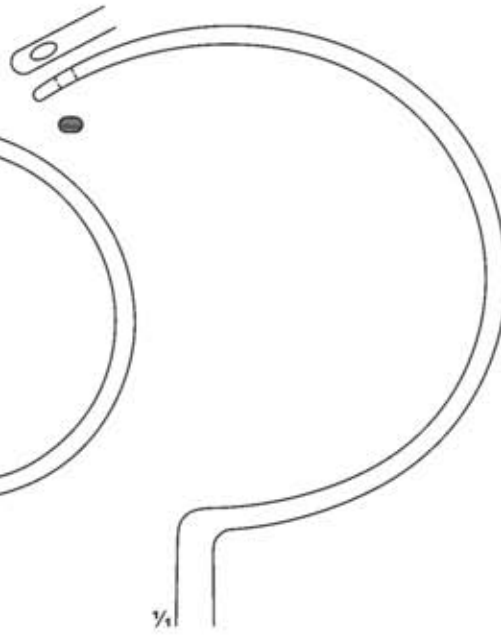

06-8614
305 mm



06-8612 - 06-8614
DEMEL
Wire guides

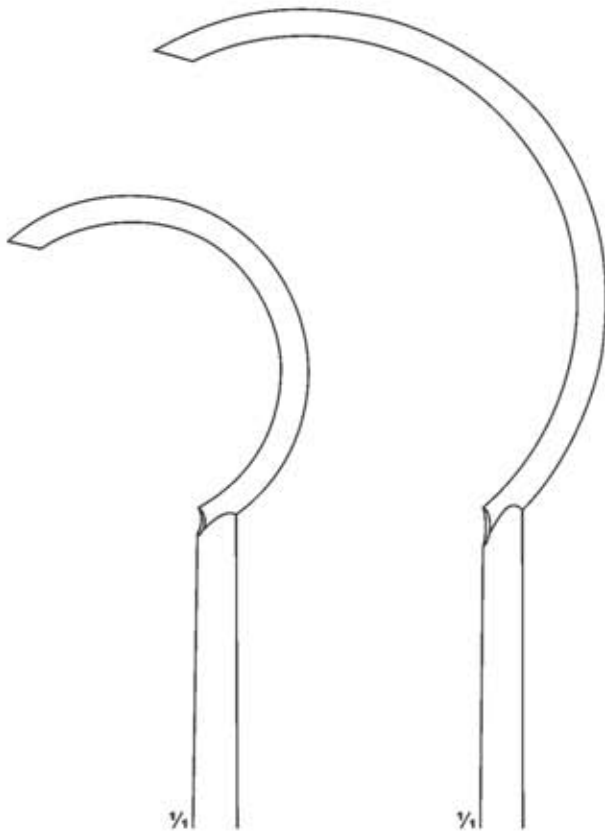

06-8615
240 mm



06-8616
270 mm

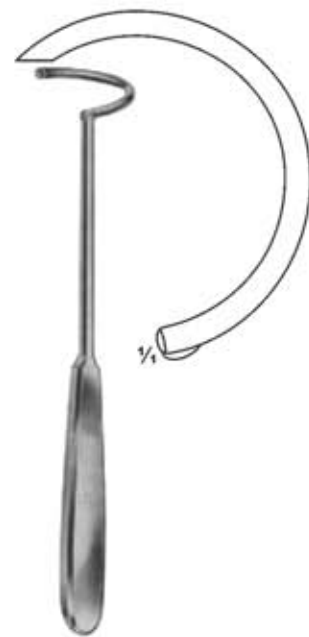

06-8617
225 mm

JORDAN instruments for subcutaneous Tibia Cerclage

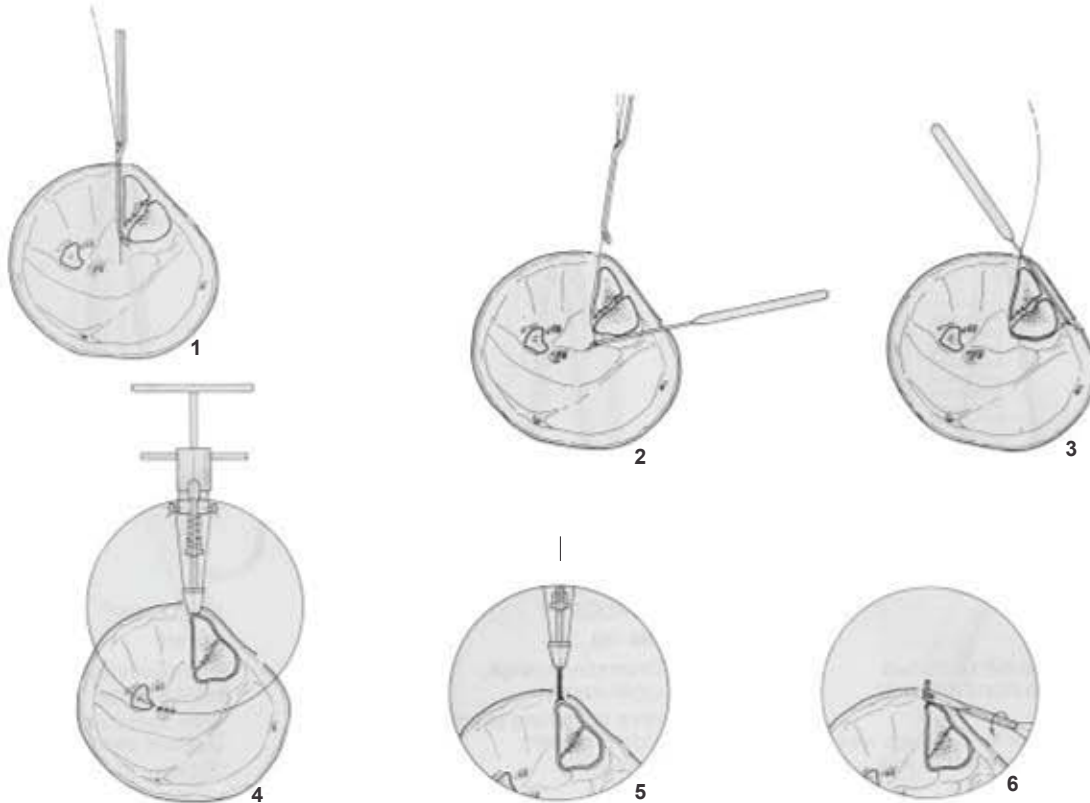

06-8618
JORDAN
Wire tightener



06-8619
JORDAN
Wire twister
170 mm



06-8620
JORDAN
Wire catcher
180 mm



06-8621
JORDAN
Probe, cannulated
170 mm

Wire Holding forceps, Wire Tightening Pliers, Flat-nosed Pliers DUROGRIP with Hard Metal Inserts



06-8622
DUROGRIP
Holding forceps for cerclage wire, with lateral jaws to avoid wire slipping off
170 mm



06-8623
DUROGRIP
Wire, tightening pliers, Ligature pliers
150 mm



06-8624
DUROGRIP
Wire, tightening pliers, Ligature pliers
150 mm



06-8625
with serrated jaws
140 mm

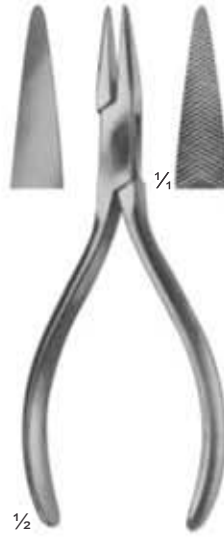

06-8626
one jaw smooth, one jaw serrated
140 mm



06-8627
with serrated jaws
06-8628
with longitudinal and transversal grooves
170 mm



06-8629
190 mm

Wire Holding forceps, Flat-nosed Pliers, Pliers for bending and cutting wires

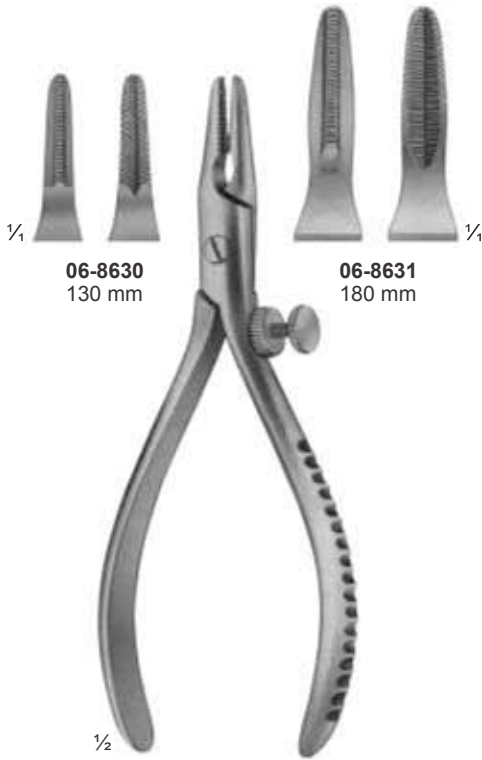

06-8630
130 mm

06-8631
180 mm

06-8630 - 06-8631
Extraction pliers
for boring wires

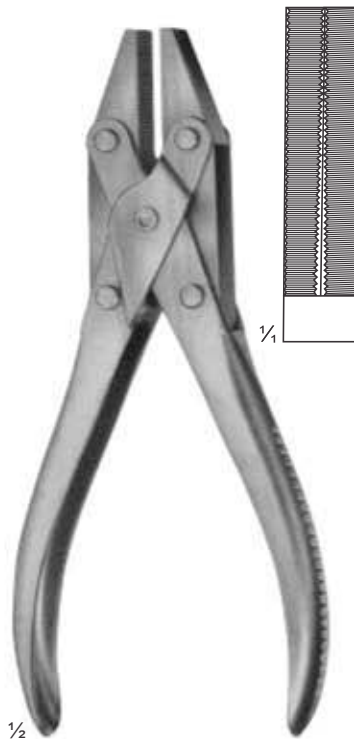

06-8632
Flat-nosed pliers,
parallel
185 mm

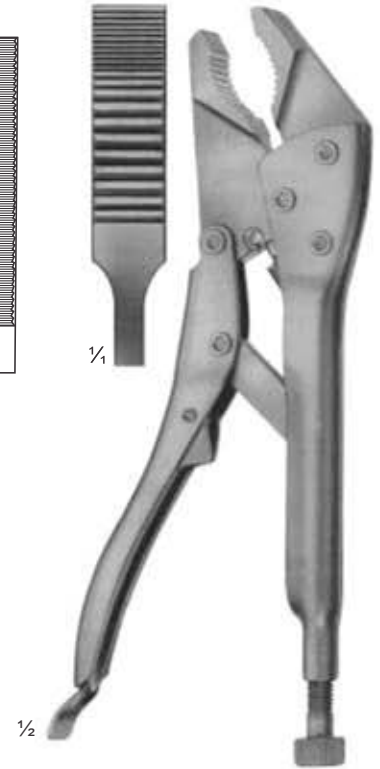

06-8633
Vise grip
200 mm

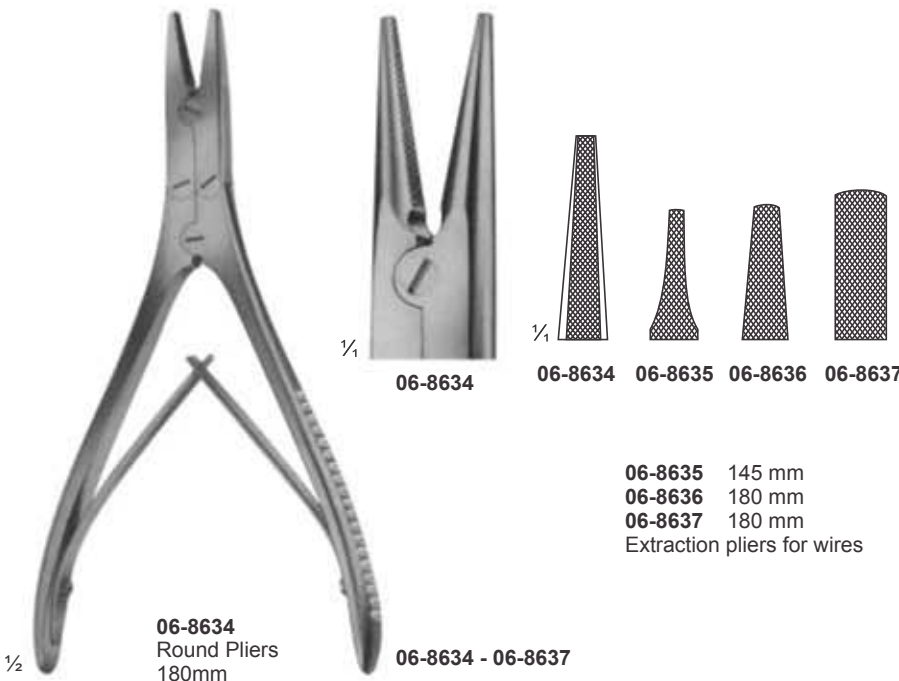

06-8634
Round Pliers
180mm

06-8634 - 06-8637

06-8635 145 mm
06-8636 180 mm
06-8637 180 mm
Extraction pliers for wires



06-8638
Bending pliers
for wires up to
1.8 mm diam.

Wire Cutters and wire Cutting Scissors DUROTIP with Carbide Cutting Edges



06-8639
ANGLE
130 mm

for soft wire
up to diam.
for hard wire
up to diam.

0,5 mm
0,3 mm

06-8640
DUROTIP
ANGLE
130 mm

0,6 mm
0,4 mm

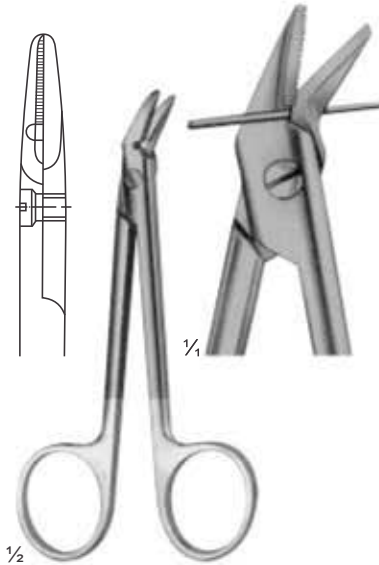

06-8641
120 mm

for soft wire
up to diam.
for hard wire
up to diam.

1,2 mm
0,8 mm

06-8642
DUROTIP
120 mm

1,2 mm
0,8 mm

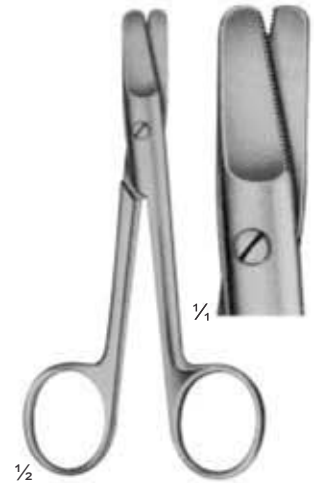

06-8643
HARVEY
125 mm

0,4 mm
0,3 mm

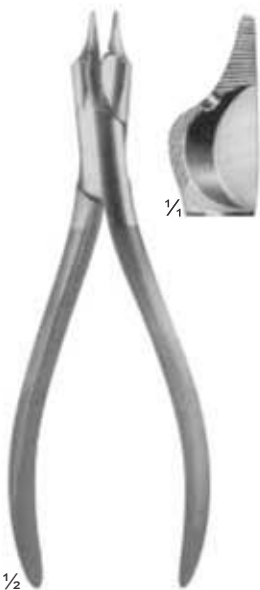

06-8644
150 mm

for soft wire
up to diam
for hard wire
up to diam

1,5 mm
1,0 mm



06-8645
160 mm

1,5 mm
1,2 mm



06-8646
140 mm
DUROTIP
1,5 mm

1,0 mm

Wire Cutting Pliers, Lateral Cutting Action

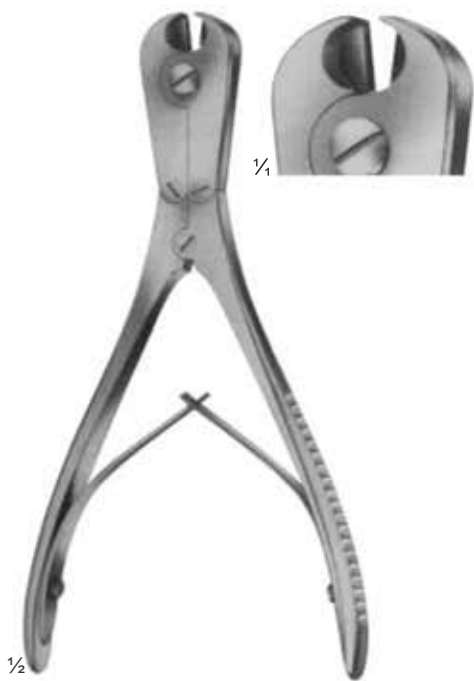

06-8647
180 mm

for soft wire
up to diam. 2,0 mm
For hard wire 1,5 mm
up to diam
specially hardened
cutting edges, front
and lateral cutting
action



06-8648
REILL
175 mm

for soft wire
up to diam. 2,0 mm
For hard wire 1,6 mm
up to diam
specially hardened
cutting edges, for
cutting off wires close
to the bone



DUROTIP

06-8649
235 mm

for soft wire
up to diam. 3,0 mm
For hard wire 2,2 mm
up to diam

Wire Cutting Pliers, Lateral and Front Cutting Action



06-8650
240 mm

for soft wire
up to diam. 2,0 mm
For hard wire
up to diam 1,6 mm

specially
hardened
cutting
edges



06-8651
145 mm

for soft wire
up to diam. 1,5 mm
For hard wire
up to diam 1,0 mm

Durotip



06-8652
145 mm

for soft wire
up to diam. 2,0 mm
For hard wire
up to diam 1,5 mm

Durotip



06-8653
220 mm

for soft wire
up to diam. 3,5 mm
For hard wire
up to diam 2,5 mm

Durotip

Wire Cutting Pliers



06-8654
320 mm

for soft wire up to diam. 3,0 mm
For hard wire up to diam 3,0 mm



Cutter for cutting off KIRSCHNER wires, Tibia head screws, bolts, pins, up to 3 mm diam.



DUROTIP

06-8655
Cutter for cutting off KIRSCHNER wires, Tibia head screws, bolts, pins, up to 6 mm diam. 470 mm

Finger Nail Instruments

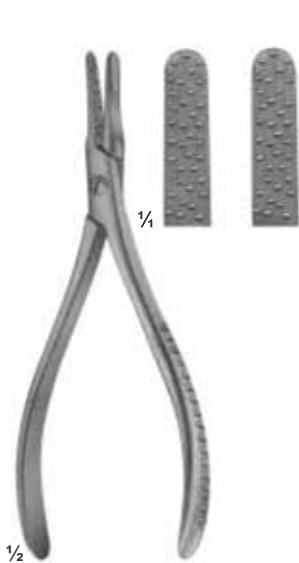

06-8656
Nail extracting
forceps
135 mm



06-8657
Nail extracting
forceps
145 mm



06-8658
Finger nail drill
with 3 drill points

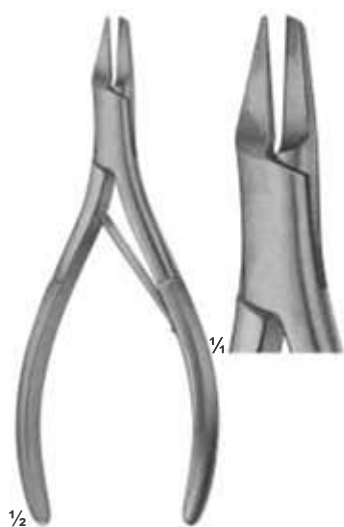

06-8662
Nail splitting
forceps
135 mm



06-8663
SYSTRUNK
Scissors, for splitting
finger nails
130 mm



06-8664
Finger ring saw
150 mm

Plaster Instruments



Plaster Knives



with ebony handle

1/2
07-9001
HOPKINS
200 mm



1/2
07-9002
ESMARCH
180 mm

Plaster Saw



1/2
07-9003
ENGEL
160 mm